

GAPOSA

XQ *Spileo* XS 40 50 60

*Tubular motors with obstacle detection
And automatic limit setting for zip-screens*

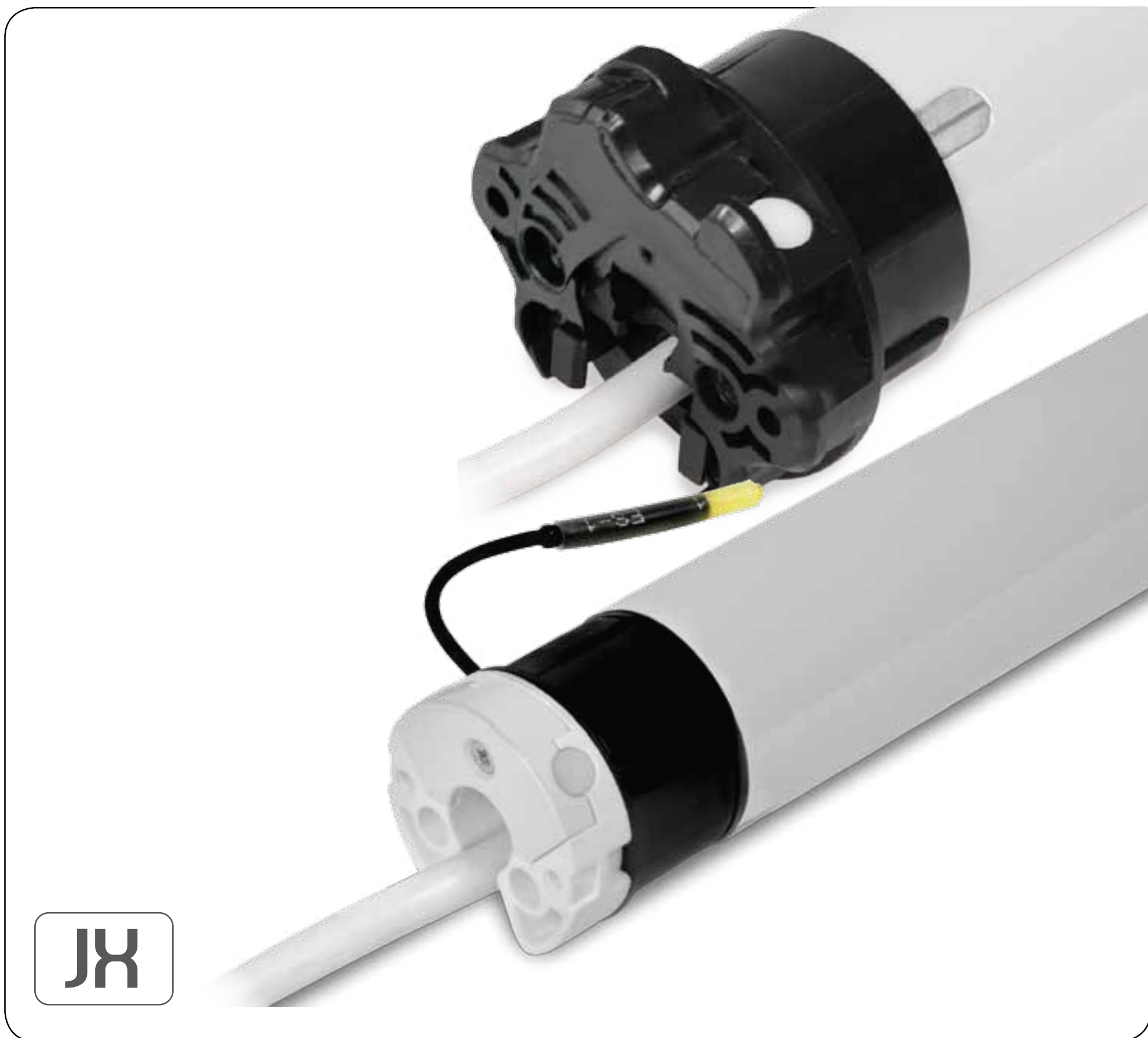

Made in Italy

CE

INDEX

SAFETY

INSTALLATION

ELECTRICAL CONNECTION

PROGRAMMING TRANSMITTER

ADDING TRANSMITTER

CHECKING/CHANGING DIRECTION

ERASING TRANSMITTER

RESET MOTOR MEMORY

LIMIT SWITCH SETUP

OBSTACLE SENSITIVITY

INTERMEDIATE POSITION



**CAREFULLY FOLLOW THESE INSTRUCTIONS.
IT IS VERY IMPORTANT FOR THE SAFETY OF
PERSONS.**

SAVE THESE INSTRUCTIONS. IMPORTANT:

- Check the shutter/awning in motion and keep persons far from it while in action.
- Frequently check if any loss of balance, signs of wear or damaged wires are shown.
- Do not use if any repairing or maintenance is needed.
- In case of installation in awnings keep a distance of at least 0,4 m from it (completely open) and whatever fixed item in the nearby.
- The device is not intended to be used by people (including children) whose physical, sensory or mental capabilities are reduced, or lacking experience or knowledge, unless they have been granted through the intermediary of a person responsible for their safety, supervision or instruction concerning the use of the device.
- Children should be supervised to ensure they do not play with the device and / or with fix control devices.
- The control devices installed in a fixed manner must be positioned in view.

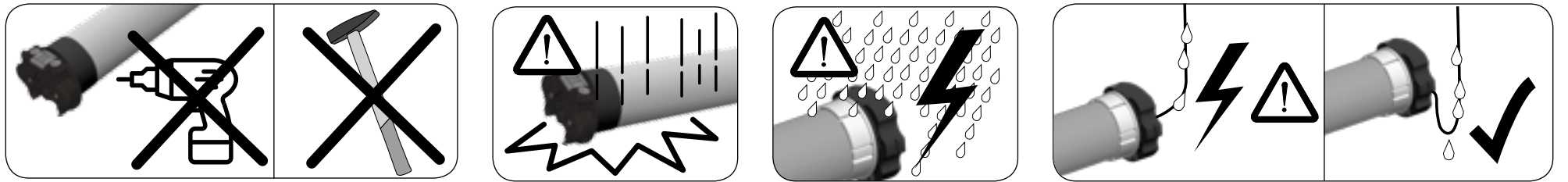

To complete installation, the motor must be provided with a couple of adaptors (corresponding with the tube) and a fixing bracket. For a list of the available accessories, refer to the catalogue.

WARNING: incorrect installation can cause serious injuries. Follow the installation instructions. Before you remove all unnecessary cables and turn off any equipment not required for this operation.

1

Fix the adaptors to the motor distinguishing the limits ring (A) from the drive pulley (B).



2

Insert the motor (E) into the tube (F) until its end stops against the limits ring.





- 3** The fixing bracket (C) must be fixed inside the box or on the awning frame so that the roller tube (F) is perfectly horizontal and at a height not less than 1,8m.

- 4** **[FOR XQ50]** Place the motor square pin (D) on the bracket (C) and the cap at the opposite end of the tube on the fixing plate.
WARNING: Never hit on the head of the motor (D) when you insert it into the tube.

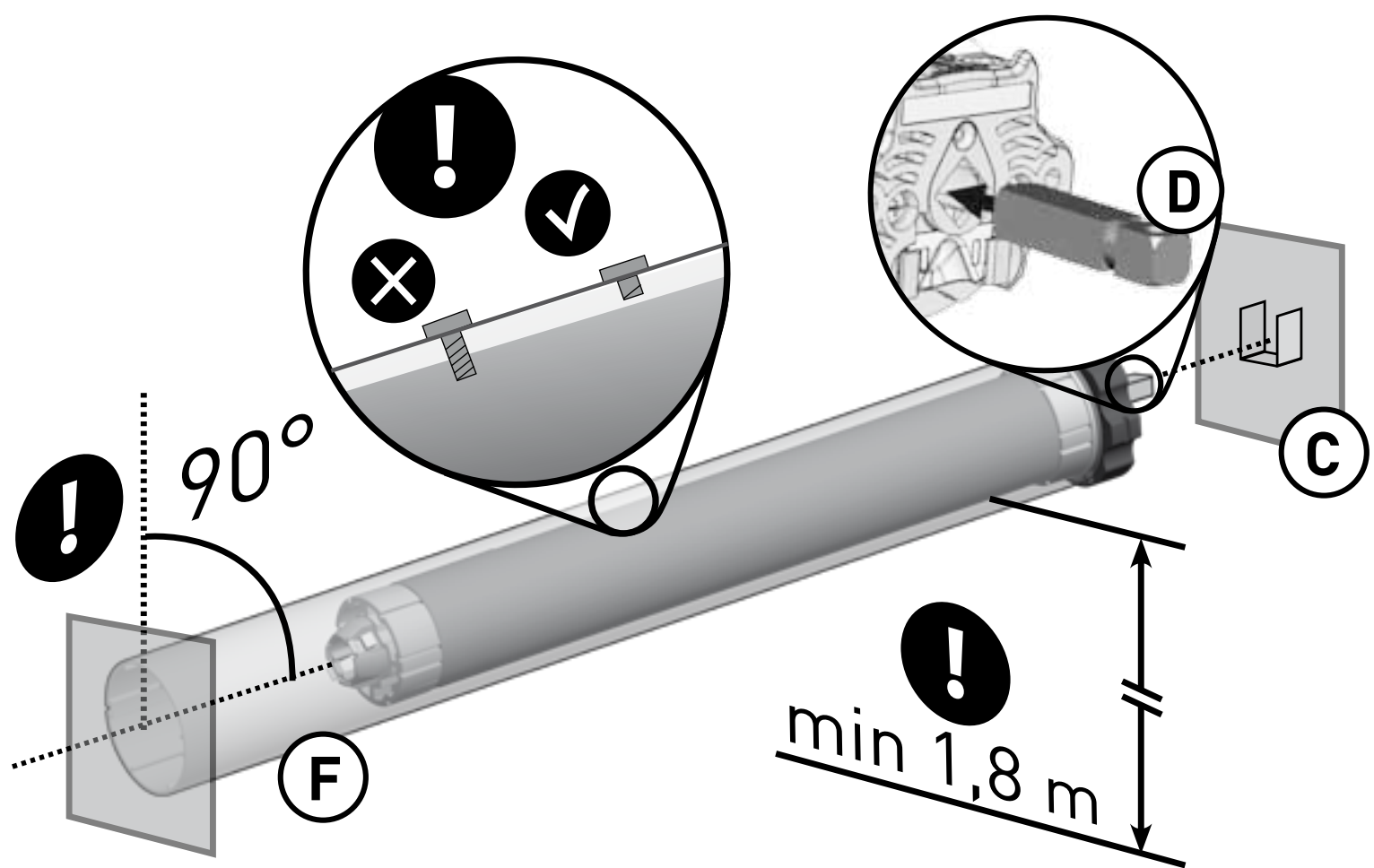

NOTES

- For the XQ50, with torque up to 15Nm, the minimum tube diameter is 50x1,5mm; for motors with higher torques, the minimum tube diameter is 60x1,5mm.
- For the XQ60, the minimum tube diameter is 63x1,5mm.

WARNING:

- The screws used to fix the last slat on the tube may be too long and reach the tubular part of the motor. Use appropriate screws or fixing clips.
- Motor moving parts installed under 2,5m from the ground must be protected.
- A wrong motor installation can damage persons or objects.

ELECTRICAL CONNECTION



Check that the mains voltage available on the system is as shown on the label. The motor mains connection should be executed according to the diagram on the next page, by qualified technicians able to operate in compliance with the rules.

ATTENTION: The power supply must contemplate a switching device with an opening distance between contacts of at least 3mm.

The motors connecting cables to the network can only be replaced with cables of the same type provided by the motor manufacturer.

- Do not connect more than one tubular motor to a single switch.
- Do not set the shutter/awning into motion while you are cleaning or servicing the device and disconnect the supply.
- The switch controlling the motor must be installed in full view, not higher than 1,5m and it must be kept far from moving parts.

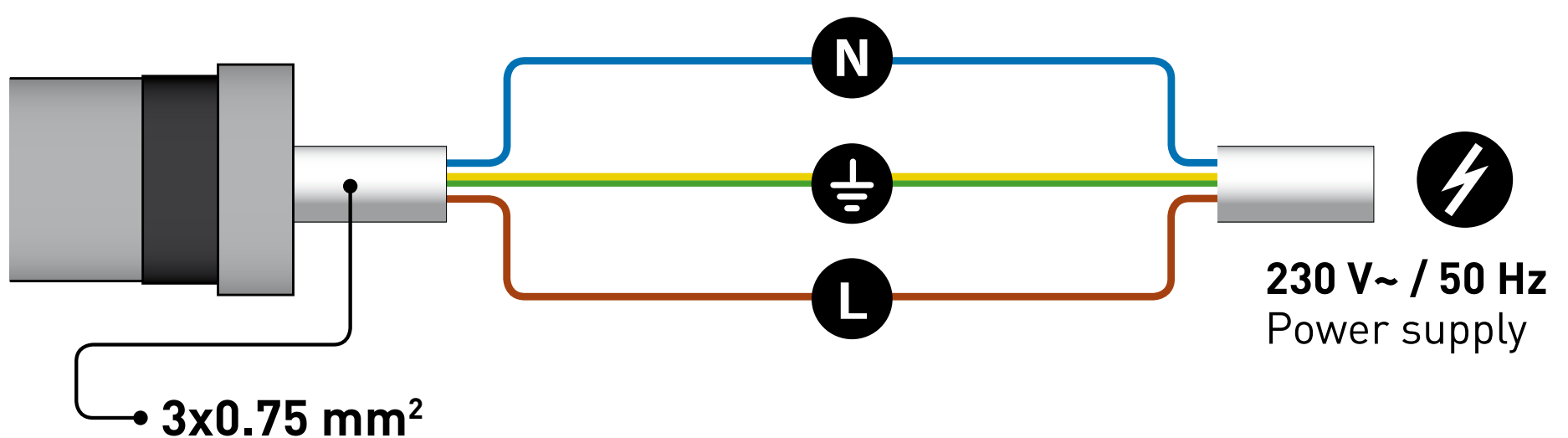

N Neutral	Blue
⏚ Ground	Yellow/Green
L Phase	Brown



PROGRAMMING TRANSMITTER

CAUTION: If more motors with receiver have to be installed, it is important to power up **only one motor at time** during the first programming session, in order to avoid any interferences with others.

1

Power up the motor to be programmed.

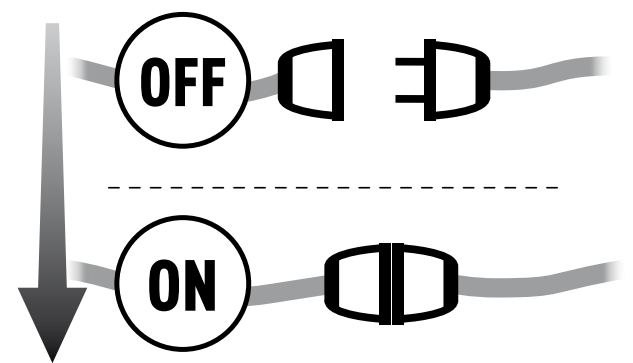

2

Press and hold the PROG-TX button until the motor starts moving.

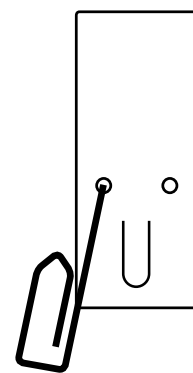

3

Check the rotation of the motor, then release PROG-TX (the motor stops).

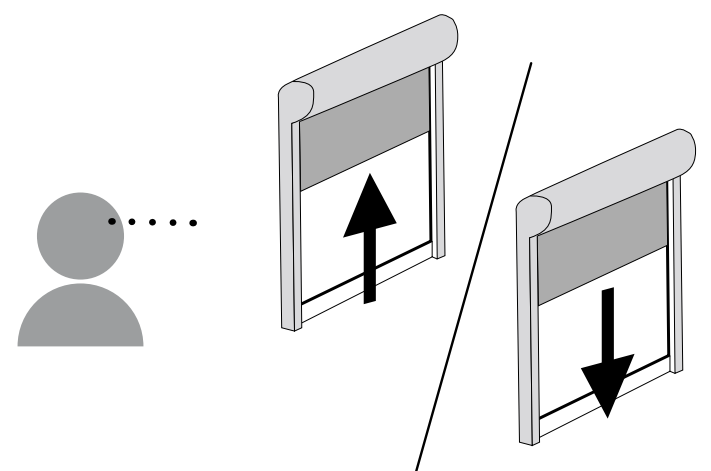

4

Within 5 seconds press the corresponding button (i.e. UP if the motor rotates upwards or DOWN if vice versa).
The transmitter has been programmed and the rotation of the motor has been synchronized.

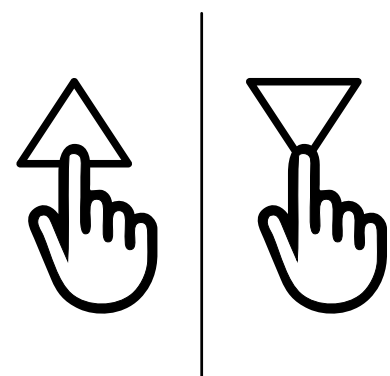



ADDING TRANSMITTER

1

Press and Hold the PROG-TX button of a transmitter **already paired** until the motor starts moving.

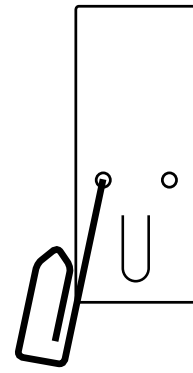

2

Check the rotation of the motor, then release the PROG-TX button (the motor stops).

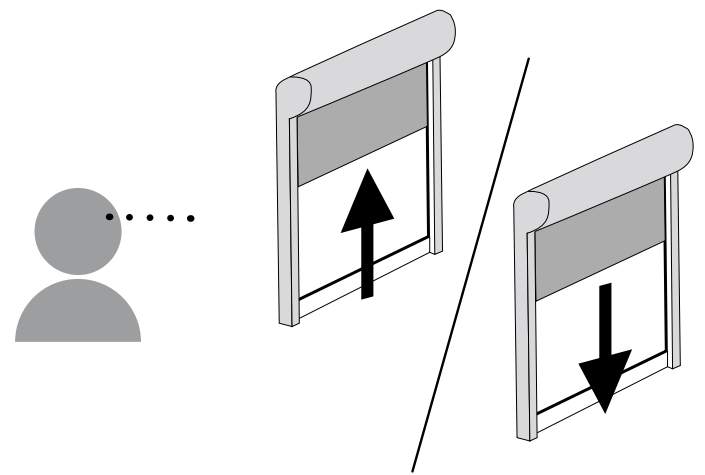

3

Within 5 seconds press the corresponding button (i.e. UP if the motor rotates upwards or DOWN if vice versa) on the **new transmitter being added**.

The new transmitter has been programmed and the rotation of the motor has been synchronized.

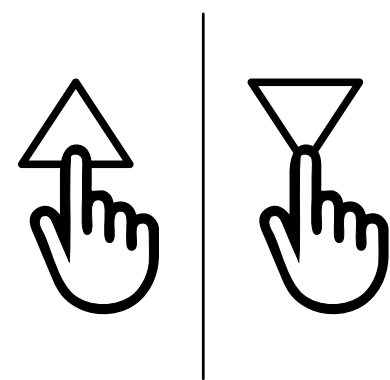



CHECKING/CHANGING DIRECTION

IMPORTANT: change direction must be performed before starting limit setting otherwise limits must be reset.

Press UP or DOWN the motor should go UP or DOWN, otherwise to change direction:

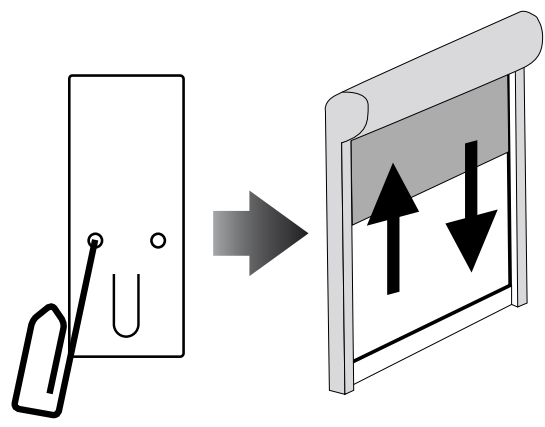
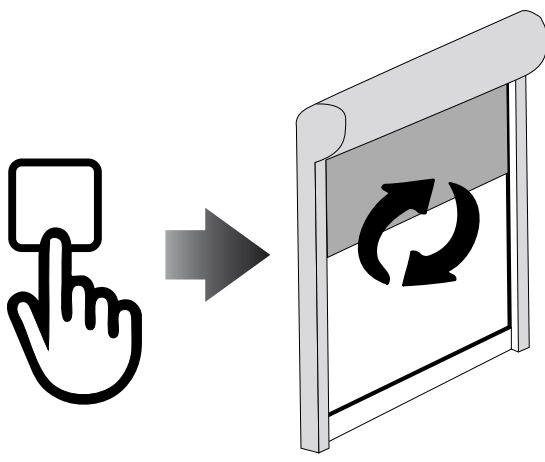
1	Press and hold the PROG-TX button until the motor starts moving	
2	Press STOP: The motor makes a brief jog. Direction of the motor has been reversed.	

ERASING TRANSMITTER

Push simultaneously the PROG-TX button and STOP of the transmitter until the motor makes a brief movement in both directions.

Only the transmitter used for this procedure has been deleted from motor memory.

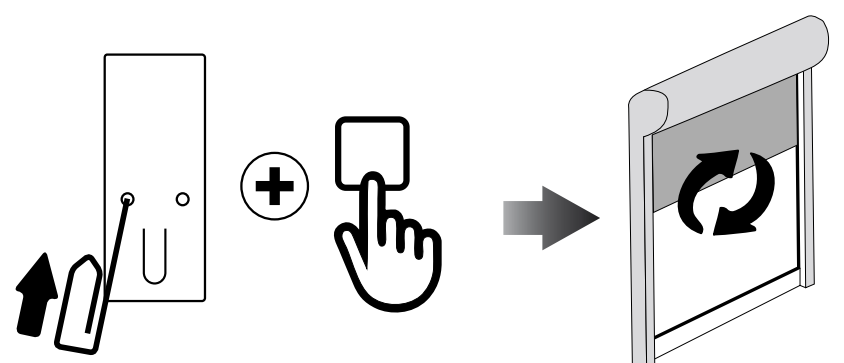



RESET MOTOR MEMORY

OPTION 1 - Using an already programmed transmitter

Press and hold both the PROG-TX and STOP buttons until the motor makes first a brief jog and, after a while, a second, long jog. Memory is now empty.

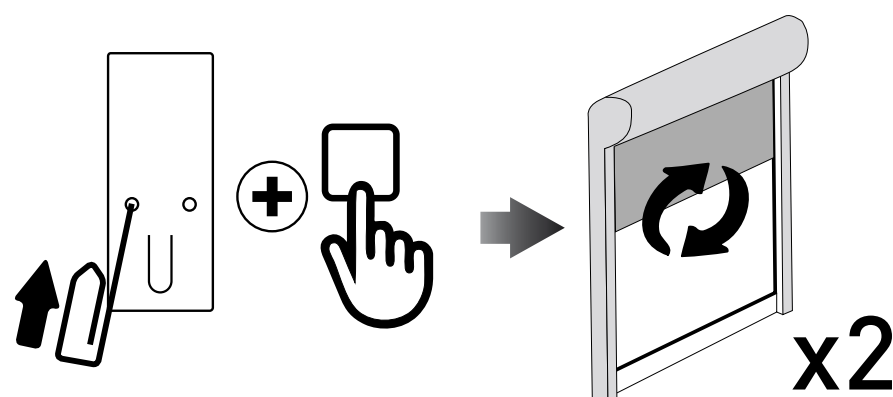

OPTION 2 - Without an already programmed transmitter

1

Switch the motor power supply OFF. Then switch it ON.

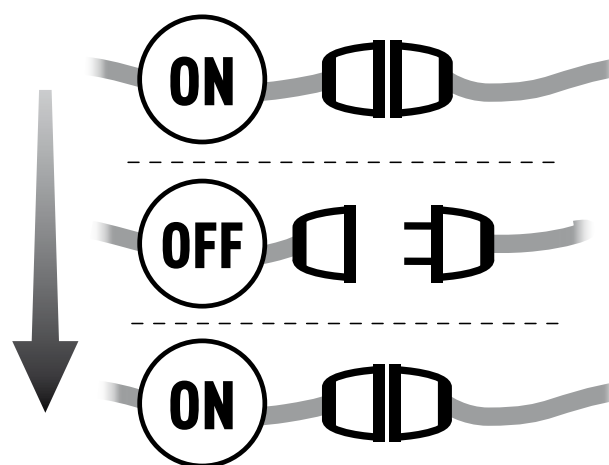

2

Within 8 seconds, using any Gapososa transmitter, press and hold both the PROG-TX and STOP buttons until the motor makes first a brief jog and, after a while, a second, long jog. Memory is now empty.

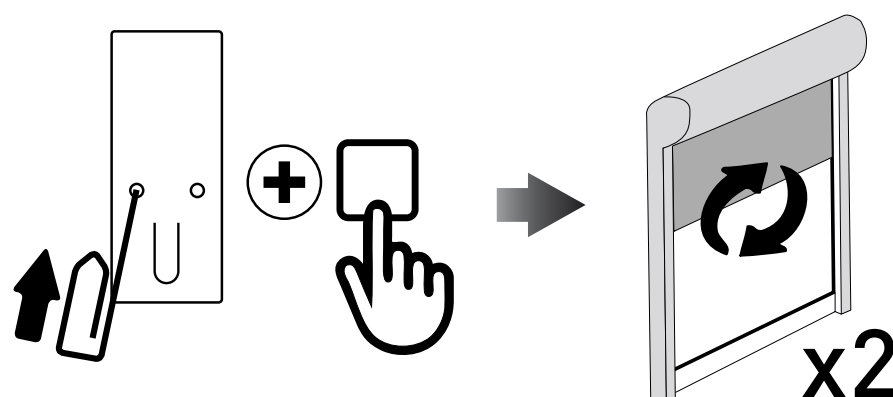



AUTOMATIC LIMIT SETTING

Note: the zip screen must be equipped with stops (A) and automatic locks (B)

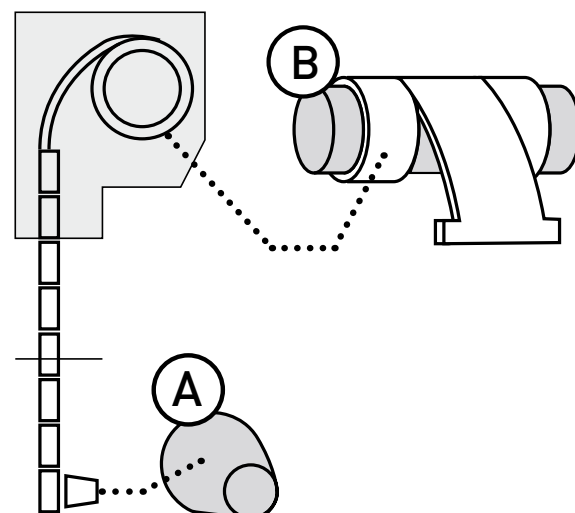

1

Press and hold the UP button for more than 2 seconds then release. The motor runs upward to the TOP limit, stops itself (because the bottom bar beats against the cassette) and sets the TOP limit.

After few seconds it starts running automatically downwards to self-set the BOTTOM limit.

When the Roller shutter is completely closed the motor stops setting the BOTTOM limit

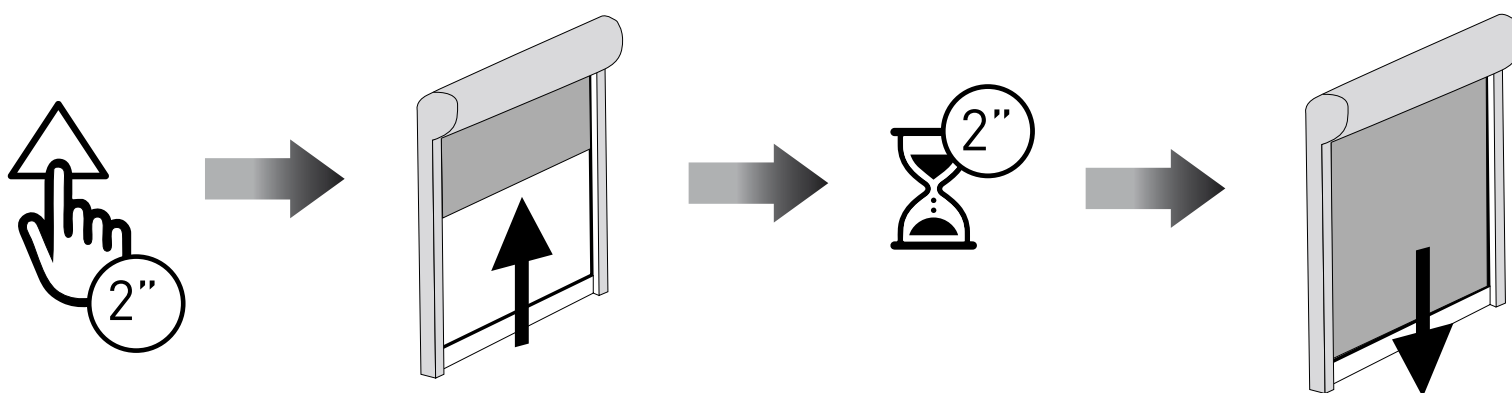

2

To double check make a full TOP/BOTTOM cycle of the roller shutter

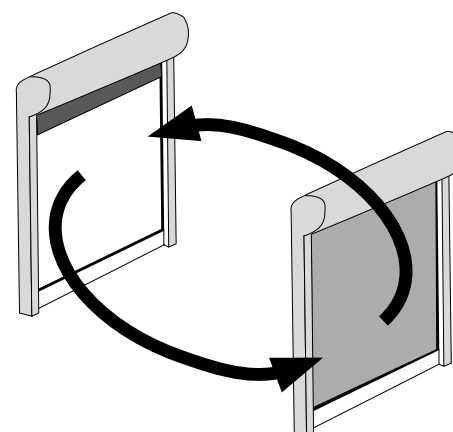



MANUAL LIMIT SETTING

NOTE: The manual limit setting allows the TOP or BOTTOM limit to be set automatically by leaving the motor running and self-stopping to the TOP end (cassette) or to the BOTTOM end.

1

Press and hold PROG-FC button until you get a jog then release.

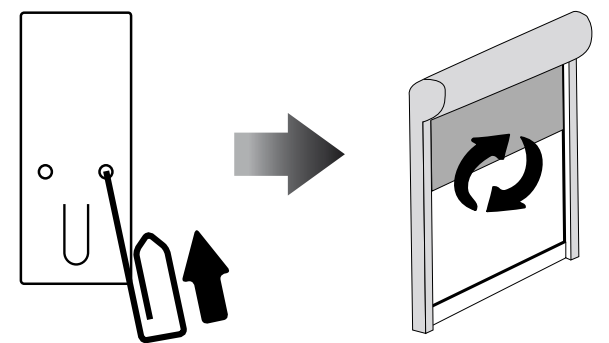

2

Press and hold the UP button for more than 2 seconds then release.
The motor runs to the TOP limit.

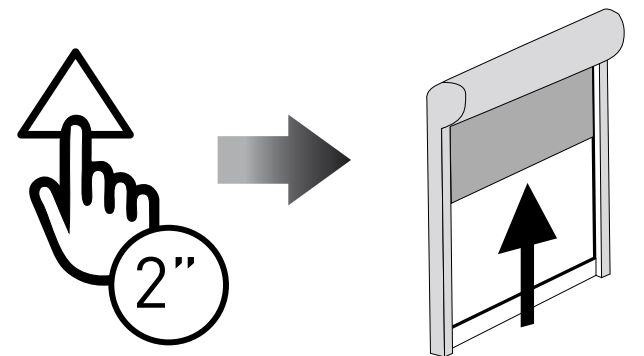

3

When you reach the TOP limit position press STOP. The motor stops.

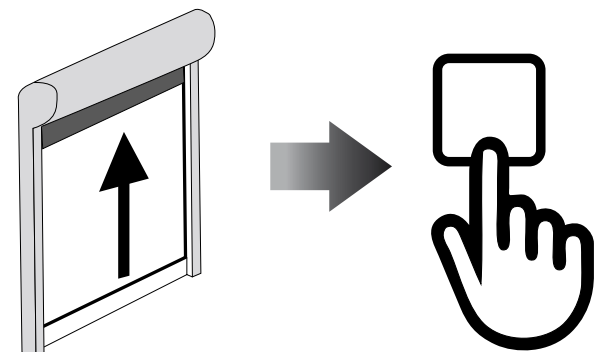

4

To set the TOP limit press STOP **again**.
The motor jogs. TOP limit is now set.

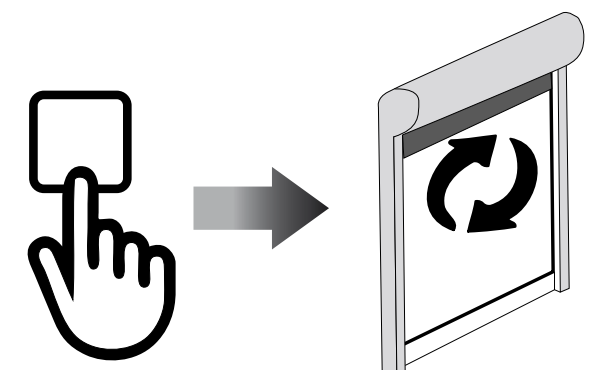



MANUAL LIMIT SETTING

5

Press and hold the DOWN button for more than 2 sec then release. The motor runs to the BOTTOM limit.

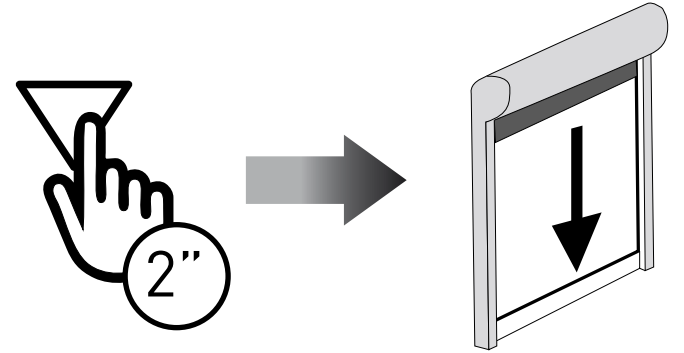

6

When you reach the DOWN limit position press STOP. The motor stops.

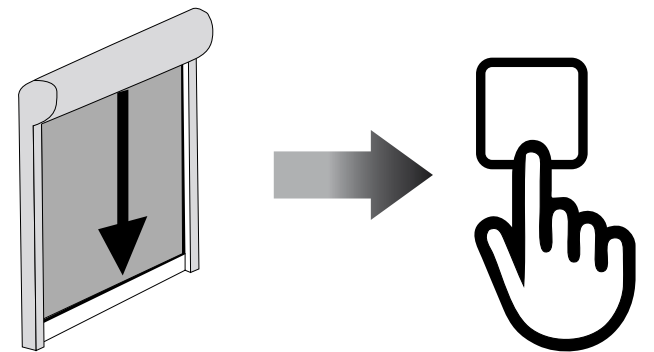

7

To set the DOWN limit press STOP **again**. The motor jogs. DOWN limit is now set.

To double check make a full TOP/
BOTTOM cycle of the roller shutter.

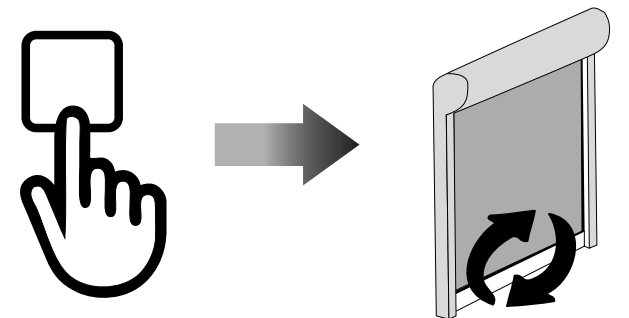

DEACTIVATING OBSTACLE SENSITIVITY



1	Press for 1 second and release PROG-FC button.	
2	Press UP button	
3	As soon as the motor runs upward press DOWN button.	
4	As soon as the motor runs downward press UP button.	
5	As soon as the motor runs upward press DOWN button.	
6	As soon as the motor runs downward press UP button.	
7	When the motor runs upward press and hold DOWN button until you get a jog as confirmation of deactivation .	

ACTIVATING OBSTACLE SENSITIVITY

Perform the same sequence. At step 7. you get **2 jogs** as confirmation of **activation**.

INTERMEDIATE POSITION



INTERMEDIATE POSITION SETUP

(Just for motors with electronic limit switch)

1

Stop the shutter/awning in the desired intermediate position.

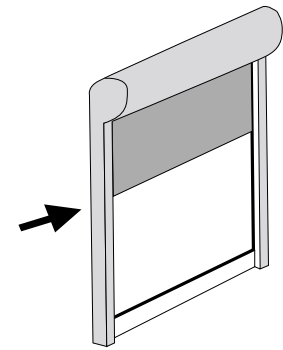

2

Press simultaneously the UP and DOWN buttons until the motor makes a brief movement in both directions.
The intermediate position has been setup.

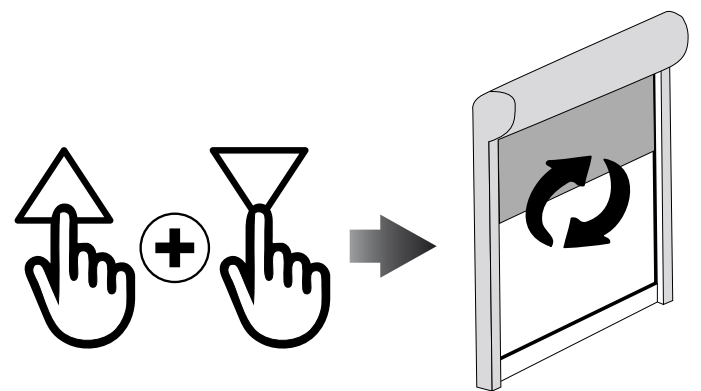

RECALLING THE INTERMEDIATE POSITION

Keep the STOP button pressed at least for at least 3 seconds.

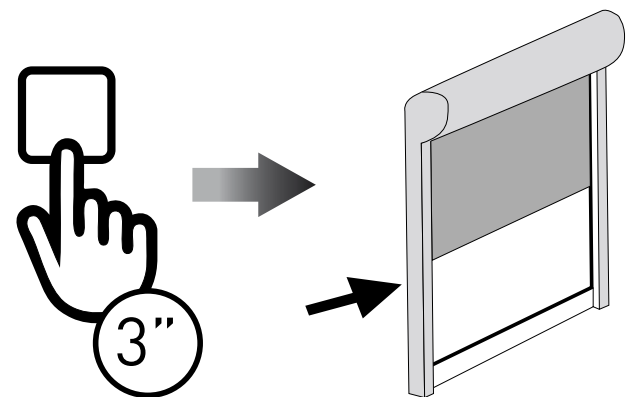

ERASING THE INTERMEDIATE POSITION

Press simultaneously, both the UP and DOWN buttons until the motor makes a brief movement in both directions.

