

# EMITTO SMART16

  
868MHz  
range

## Transmitters

**QCTX16Y**  
channels handheld  
display remote



**QCTX16SY**  
16 channels handheld  
display remote with timer

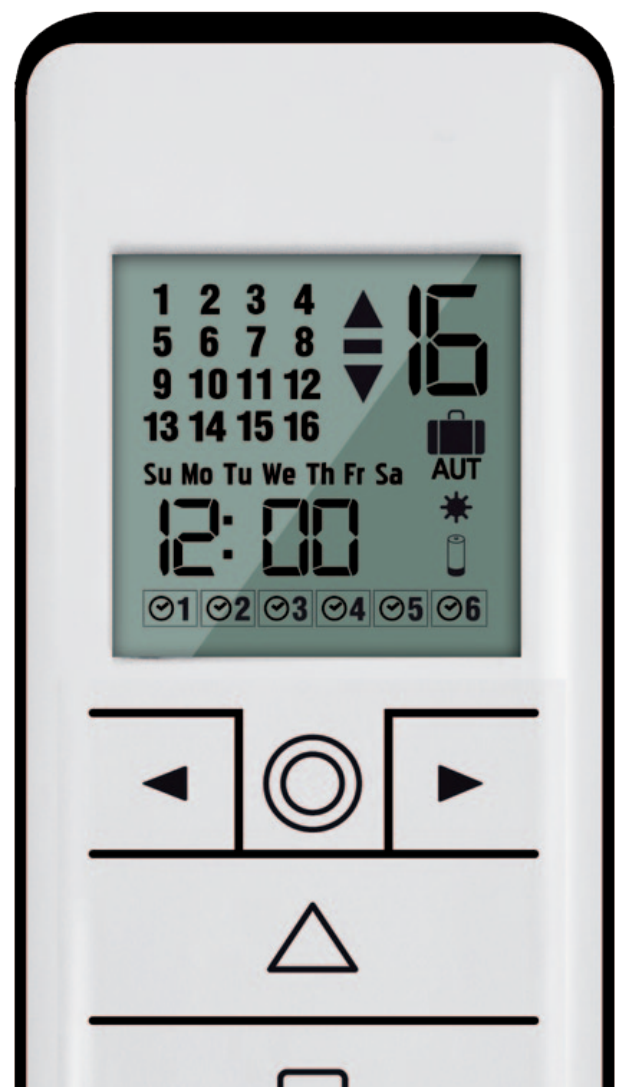

# INDEX

**TECHNICAL DETAILS**

**BUTTONS AND FUNCTIONS**

**SELECTING A CHANNEL/GROUP**

**CUSTOMIZATION OF THE GROUPS**

**DELETING GROUPS**

**HIDING CHANNELS**

**PROGRAMMING TRANSMITTER**

**ADDING TRANSMITTER**

**CHECKING/CHANGING DIRECTION**

**ERASING TRANSMITTER**

**RESET MOTOR MEMORY**

**TRANSMITTER FACTORY RESET**

**LIMIT SWITCH SETUP**

**AUTOMATIC SETTING OF THE LIMITS**

**INTERMEDIATE POSITION**

**CLOCK SET-UP**

**CREATING OR EDITING A SCHEDULE**

**SCHEDULE DELETION**

**CHANGING THE OPERATIONAL MODE**

**BATTERY SUBSTITUTION**

# TECHNICAL DETAILS

EMITTO SMART16



Battery	3V mod. CR2450
Channels	16
Encoding	RC Gaposa
Battery life	2 years
Frequency	868,30 MHz
Radiated power	0,150 mW
Protection rate	IP40
Coverage (int/ext)	20 m / 200 m
Working temperature	-5°C / +40°C

## SAFETY

Please read this guide carefully before installing and using this product. Any use outside the sphere of application defined by GAPOSA is prohibited. This invalidates the warranty and discharges GAPOSA of all liability, as does any failure to comply with the instructions given herein. Never begin installing without first checking the compatibility of this product with the associated equipment and accessories.

To avoid damaging the product:

- Avoid impacts!
- Do not drop it!
- Do not spray or immerse in liquids.
- Keep out of the reach of children.
- Do not use abrasive products or solvents to clean the product. Its surface can be cleaned with a soft, damp cloth.

**PLEASE NOTE:** do not use motors with remote controls in areas with risks of radio disturbances over the norm (i.e. airports or radio repeaters). These units may also be disturbed by telecommunication and/or transceiver systems working on the same frequency.

# PUSHBUTTONS

EMITTO SMART16

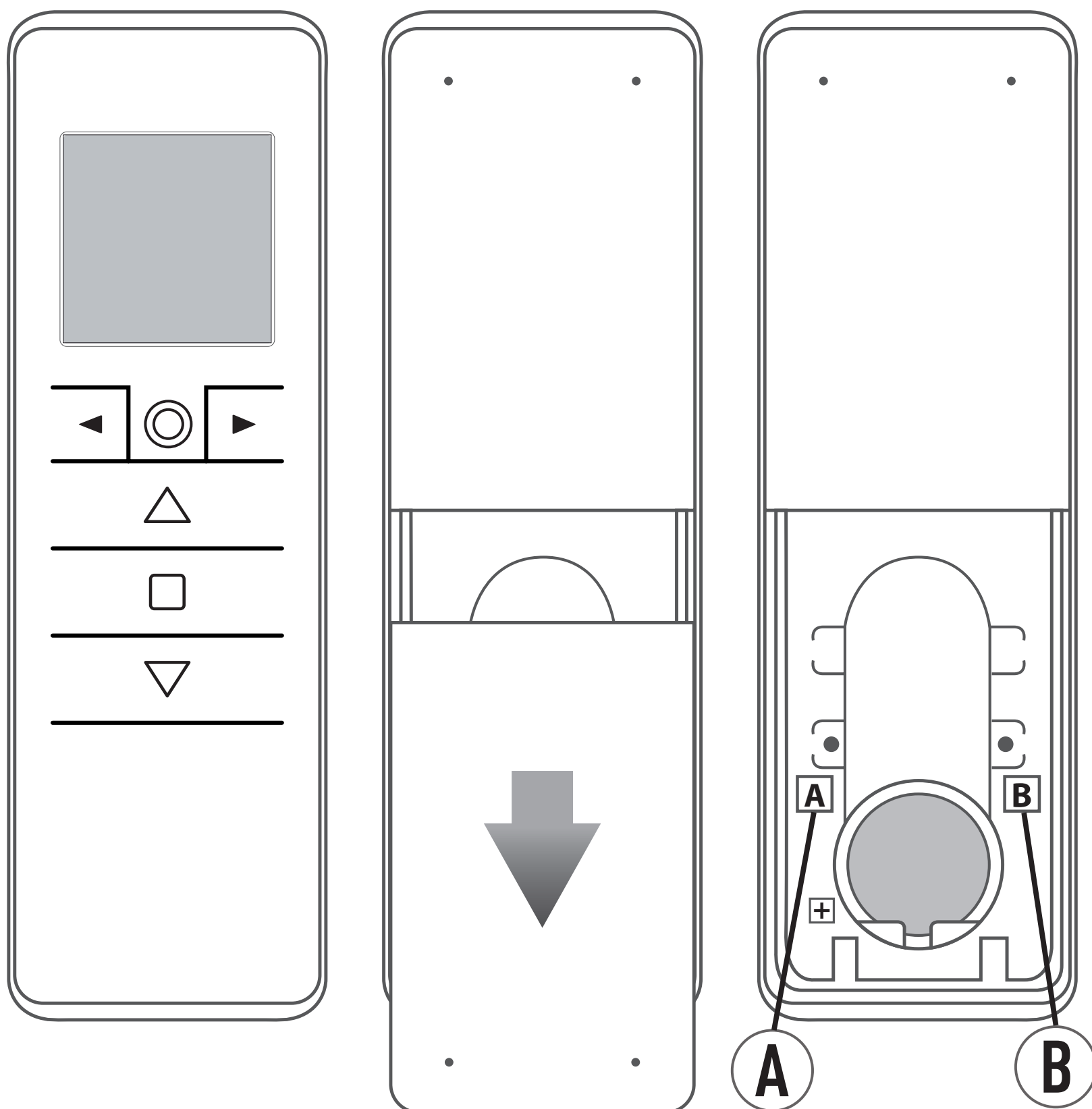

△ UP      □ STOP      ▽ DOWN

◀ ▶ Select channel

Ⓐ **PROG-TX** Program the transmitter

⊙ Single channel mode/  
Group control mode

Ⓑ **PROG-FC** Set the limit switch



## SELECTING A CHANNEL/GROUP

1

When pressing the circle button sequentially the modes can be switched from **single channel control mode** to **group control mode**.

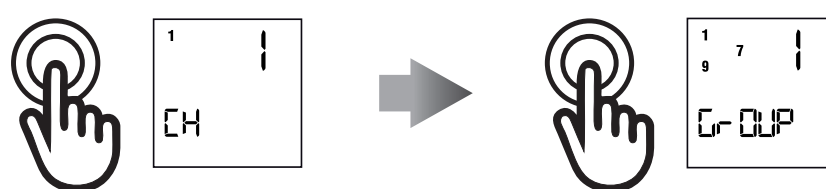

A

**Single channel control mode:** scroll the channels with the arrow buttons (◀ / ▶). Each channel is identified by a number.

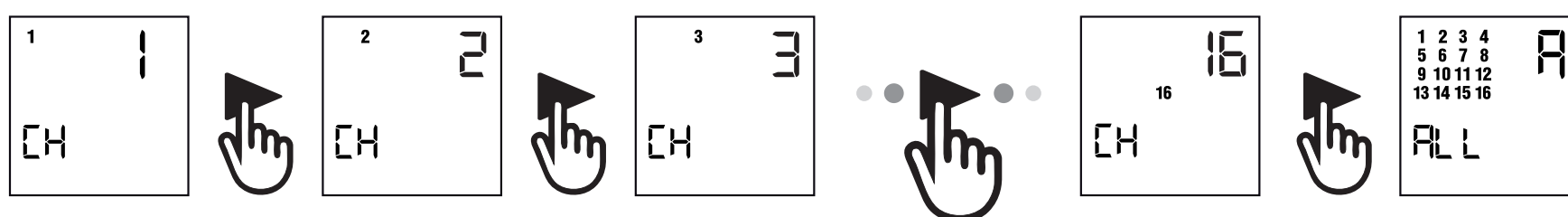

B

**Group control mode\*:** the first group to appear is the all channels group. Scroll through the pre-made groups with the arrow buttons (◀ / ▶). Each group is identified by a number.

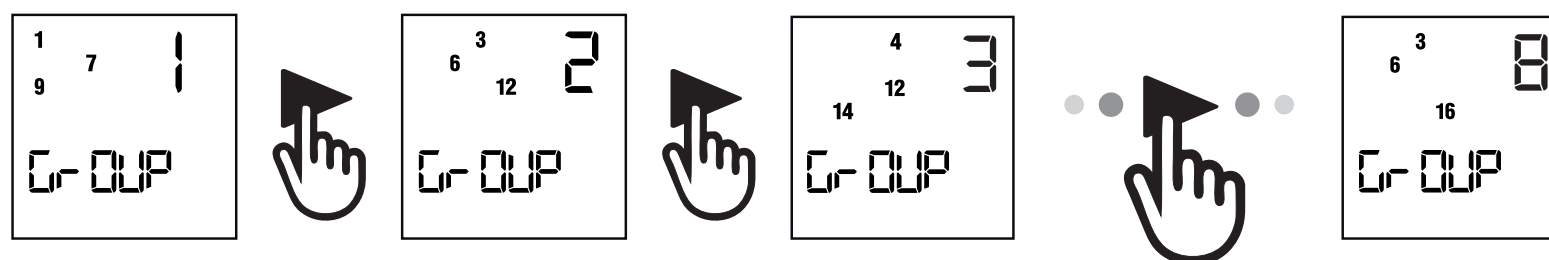

**\*Note:** Only the groups that have been created previously will appear. No groups will appear if groups have not been created previously.









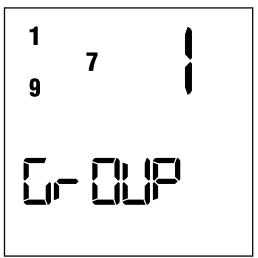

## CUSTOMIZATION OF THE GROUPS

1	<p>Briefly press the circle button to enter in group control mode</p>	
2	<p>To create a group press both arrow buttons (◀ + ▶) for 2 seconds. The icon <b>SEL</b> appears and channel 1 starts flashing.</p>	
3	<p>Using the arrow buttons (◀ / ▶), scroll to the channel to be set into the group</p>	
4	<p>Press for 2 seconds both arrow buttons (◀ + ▶) to select the channel. Repeat point 3 and 4 to add other channels in the same fashion.</p>	
5	<p>When all the desired channels of the group are set press the UP, STOP or DOWN button to confirm the group. The group is identified by a number. The group you set takes the first number available in progressive fashion from 1 to 8.</p>	

**Note: up to 8 groups can be created.**









## DELETING GROUPS

1	Enter the group screen by pressing the circle button.	 
2	Press and hold the circle button until <b>DEL G</b> appears on screen then press the STOP button to enter the delete groups mode.	 
3	Page through the saved groups using the left and right arrow buttons.	
4	Once the group that needs to be deleted is selected	 
5	Press the STOP button to confirm the deletion.	 

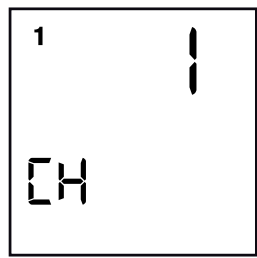
**Note: the delete groups mode can be exited at any time by pressing the circle button again.**

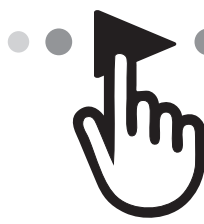
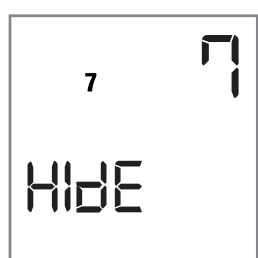

## HIDING CHANNELS

1	Enter the channel screen by pressing the circle button.	 
2	Press and hold the circle button until H I d E appears on screen.	 
3	then press the STOP button to enter the hide channel mode. ( H I d E )	
4	Once the required hidden channels are selected	 
5	Press the STOP button to confirm the hidden channels. The numbers on the screen will blink quickly for confirmation.	 

**Note: Channels can be unhidden using the same process. Just deselect the channels.**





# PROGRAMMING TRANSMITTER

CAUTION: If more motors with receiver have to be installed, it is important to power up **only one motor at time** during the first programming session, in order to avoid any interferences with others.

<p><b>1</b></p>	<p>Power up the motor to be programmed.</p>	
<p><b>2</b></p>	<p>Press and hold the PROG-TX button until the motor starts moving.</p>	
<p><b>3</b></p>	<p>Check the rotation of the motor, then release PROG-TX (the motor stops).</p>	
<p><b>4</b></p>	<p>Within 5 seconds press the corresponding button (i.e. UP if the motor rotates upwards or DOWN if vice versa). The transmitter has been programmed and the rotation of the motor has been synchronized.</p>	



## ADDING TRANSMITTER

**1**

Press and Hold the PROG-TX button of a transmitter **already paired** until the motor starts moving.

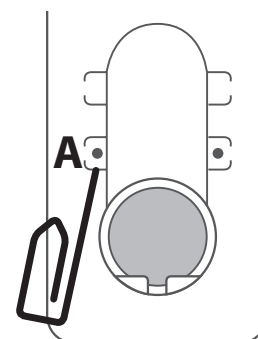
**2**

Check the rotation of the motor, then release the PROG-TX button (the motor stops).

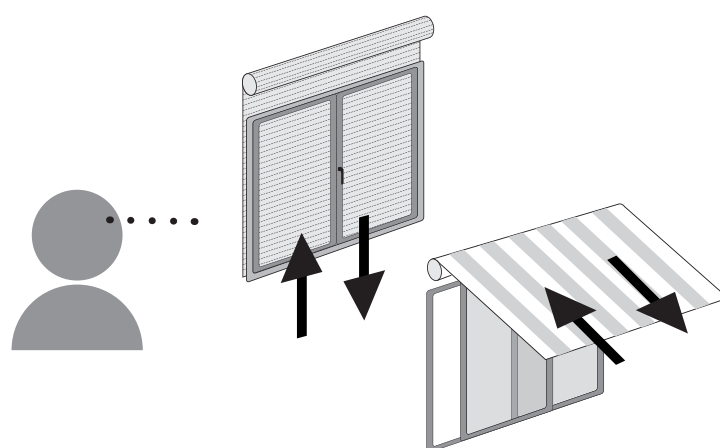
**3**

Within 5 seconds press the corresponding button (i.e. UP if the motor rotates upwards or DOWN if vice versa) on the **new transmitter being added**.

The new transmitter has been programmed and the rotation of the motor has been synchronized.

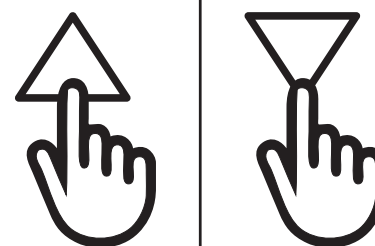



## CHECKING/CHANGING DIRECTION

**IMPORTANT:** change direction must be performed before starting limit setting otherwise limits must be reset.

Press UP or DOWN the motor should go UP or DOWN, otherwise to change direction:

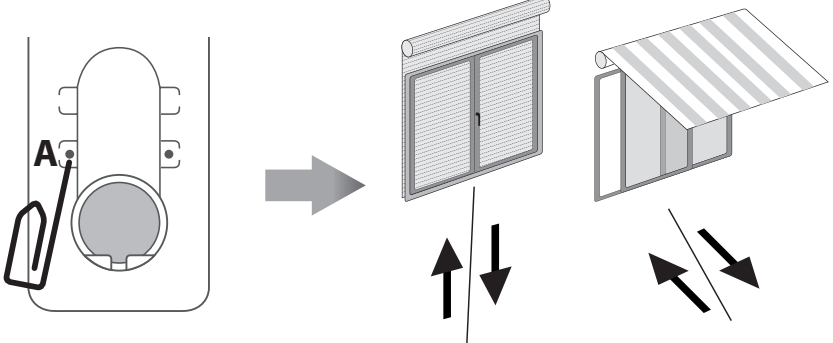
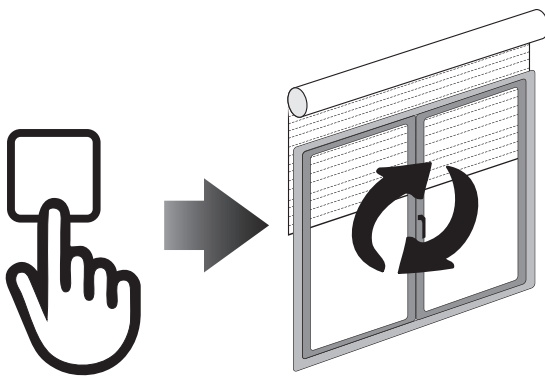
1	Press and hold the PROG-TX button until the motor starts moving	
2	Press STOP: The motor makes a brief jog. Direction of the motor has been reversed.	



## ERASING TRANSMITTER

Push simultaneously the PROG-TX button and STOP of the transmitter until the motor makes a brief movement in both directions.  
Only the transmitter used for this procedure has been deleted from motor memory.

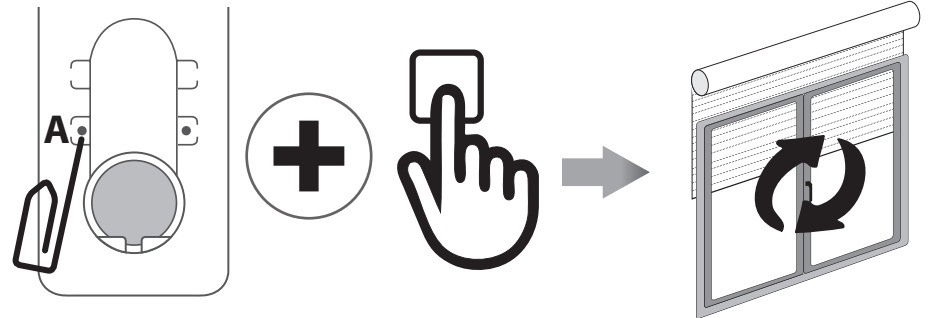

## RESET MOTOR MEMORY

### OPTION 1 - Using an already programmed transmitter

Press and hold both the PROG-TX and STOP buttons until the motor makes first a brief jog and, after a while, a second, long jog. Memory is now empty.

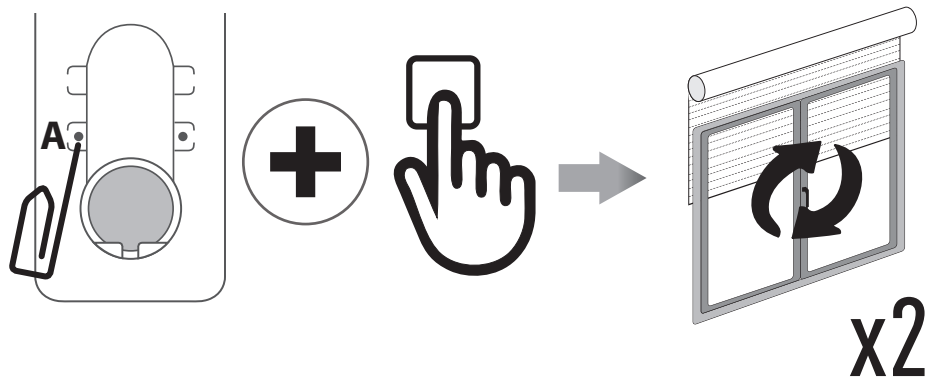

### OPTION 2 - Without an already programmed transmitter

1

Switch the motor power supply OFF.  
Then switch it ON.

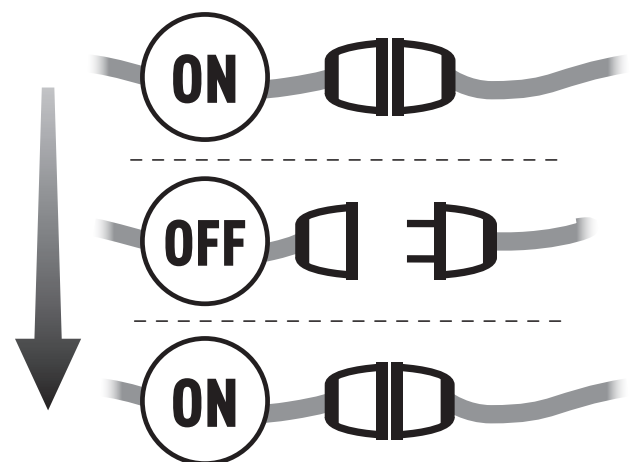

2

Within 8 seconds, using any Gaposá transmitter, press and hold both the PROG-TX and STOP buttons until the motor makes a long jog.  
Memory is now empty.

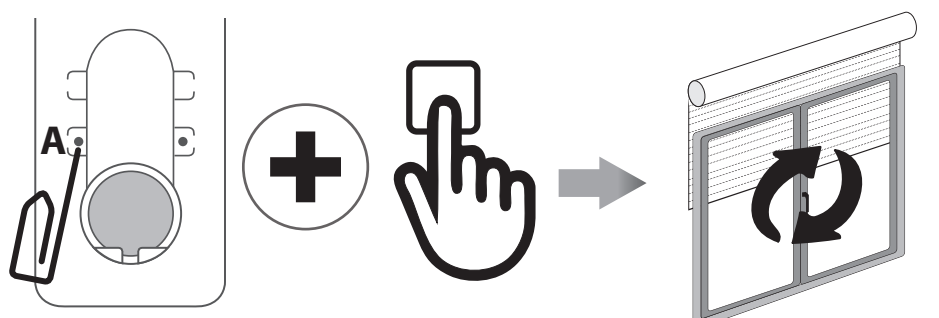



## TRANSMITTER FACTORY RESET

The factory reset will un-hide any hidden channels and delete all custom groups.

**1** Remove the battery.

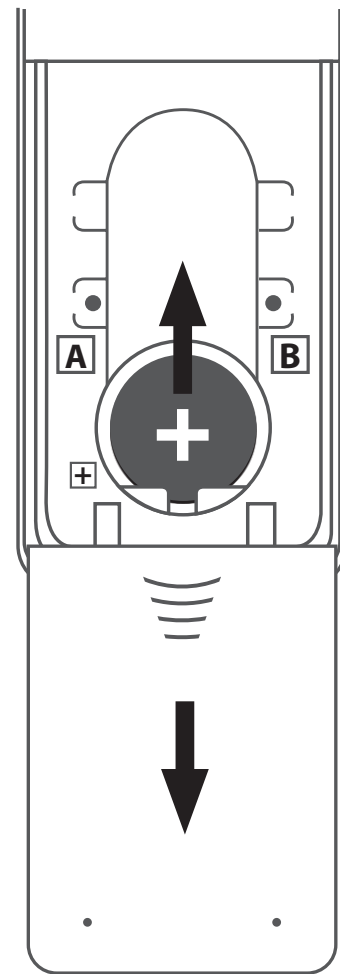

**2** Press and hold the circle button while reinserting the battery. Once the screen comes back on and displays `RESET`, the circle button can be released.

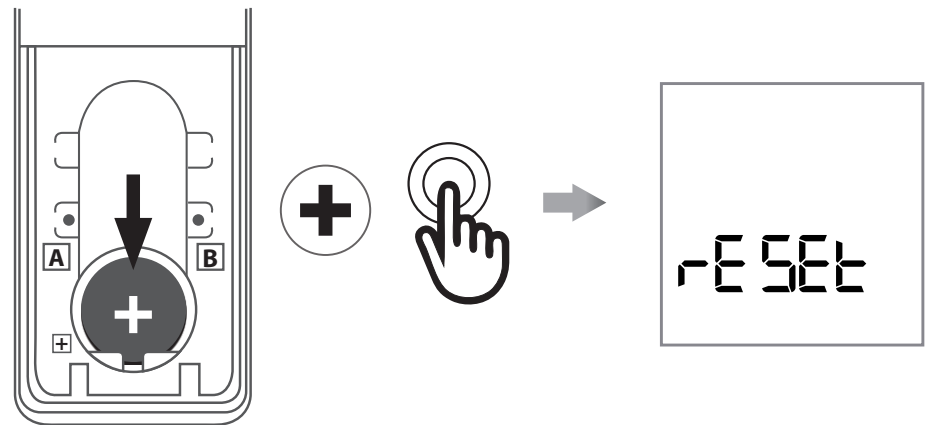

**3** After about 3 seconds the transmitter will start up and all channels will be un-hidden, and any groups deleted.

# LIMIT SWITCH

EMITTO SMART16



## LIMIT SWITCH SETUP (Just for motors with electronic limit switch)

**ATTENTION: ALWAYS SET THE UP LIMIT FIRST**

1	<p>Push the PROG-FC button until the motor makes a brief jog.</p> <p><b>Note: during “programming mode” the operations are in “deadman control”</b></p>	
2	<p>Press and hold the UP button and run the motor to the desired UP limit position.</p>	
3	<p>Press STOP to set the UP limit position. The motor makes a brief jog.</p>	
4	<p>Press and hold the DOWN button and run the motor to the desired DOWN limit position.</p>	
5	<p>Press STOP to set the DOWN limit position. The motor makes a brief jog.</p>	

Note: accurate limit setting can be performed when UPWARD or DOWNWARD by pressing the PROG-FC button a second time. The motor then moves slowly in steps towards the desired limit. Always press STOP button to set the limit position.

## AUTOMATIC SETTING OF THE LIMITS

For limits set with torque sensor (mechanical stop of shutters or cassette awnings/shades), press and hold UP button until the bottom bar hits the cassette or shutter box.

A short jog will indicate that the UP position has been memorized. The same procedure can be followed for DOWN limit but only for roller shutters.

# INTERMEDIATE POSITION

EMITTO SMART16



## INTERMEDIATE POSITION SETUP

(Just for motors with electronic limit switch)

1

Stop the shutter/awning in the desired intermediate position.

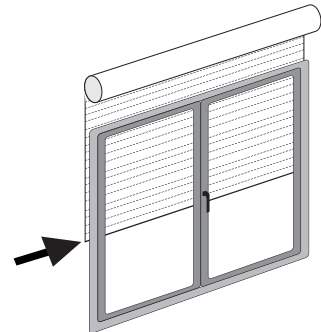

2

Press simultaneously the UP and DOWN buttons until the motor makes a brief movement in both directions.  
The intermediate position has been setup.

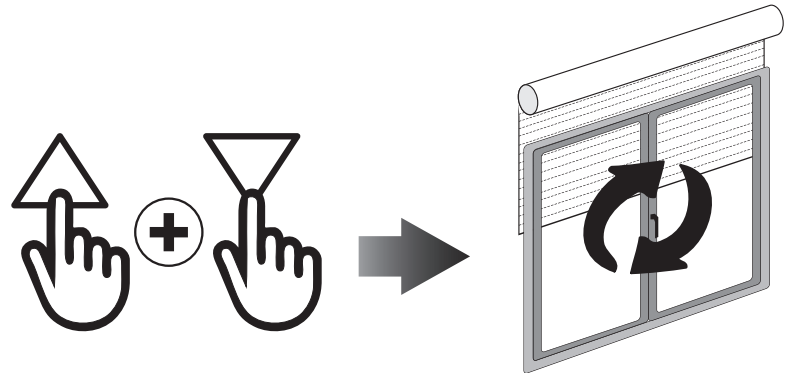

## RECALLING THE INTERMEDIATE POSITION

Keep the STOP button pressed at least for at least 3 seconds.

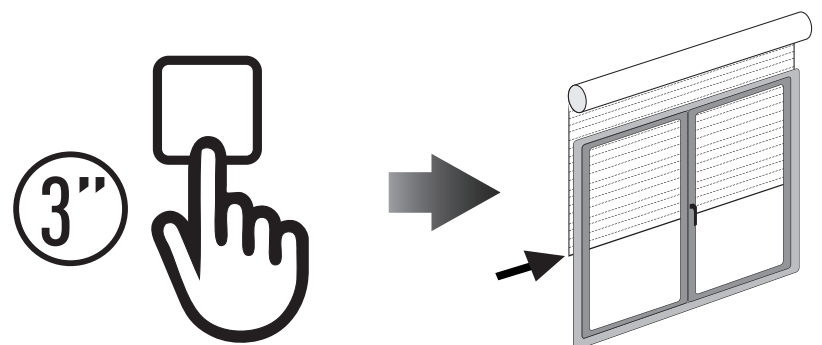

## ERASING THE INTERMEDIATE POSITION

Press simultaneously, both the UP and DOWN buttons until the motor makes a brief movement in both directions.

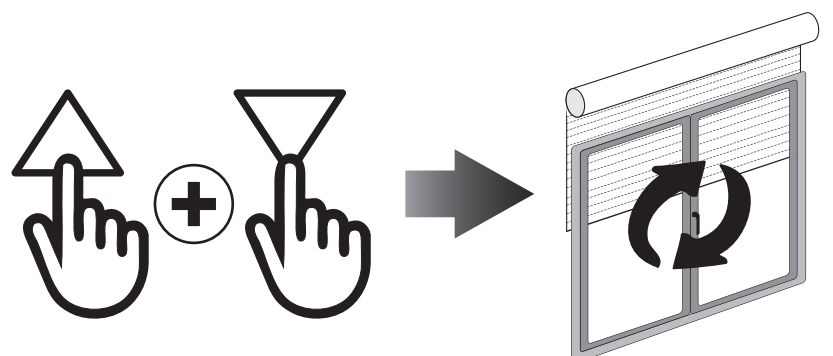



## CLOCK SET-UP

(Note: The clock is in 24-hour format)

**1**

From the channels or groups screen, press and hold the circle button until **HIDE** or **DEL** appears on the screen. Press the circle button again and the timer/clock screen will appear.

**2**

Press the STOP button to enter the menu.

**3**

Set the hour by using the UP / DOWN buttons and press the STOP button to confirm.

**4**

Set the minutes by using the UP / DOWN buttons and press the STOP button to confirm.

**5**

Select the day of the week using the arrow buttons (◀ / ▶) and press STOP button to confirm. Clock is now set.  
**OFF** now appears on screen. By using the arrow buttons (◀ + ▶) you can scroll between **OFF** and **On** to choose between having the clock displayed or not in stand-by mode.

**Note: During operation, the clock is shown only in Automatic Mode or Random Mode (see section: “Changing the operational mode”)**





## CREATING OR EDITING A SCHEDULE

1

After setting the clock, from either the channels or groups screen, press and hold the circle button until **HIDE** or **DEL** appears on the screen. Press the circle button again two times until the **PROG** screen is reached. Press the STOP to enter the menu.

2

The 6 schedules can now be chosen: **1 2 3 4 5 6**  
Use the arrow buttons (◀ / ▶) to select the schedule to be created or edited. Once the schedule is selected, press the STOP button to confirm.

3

Use the arrow buttons (◀ / ▶) to select the day of the week:  
**Su Mo Tu We Th Fr Sa**

4

Press the UP / DOWN buttons to select or deselect one or multiple days of the week. Once the day or days of the week have been selected, press the STOP to confirm.  
**Note: When the day of the week is blinking slow, the day is not selected, and when the day of the week is blinking fast, the day has been selected.**

5

Use the UP / DOWN buttons to select the hour. Press the STOP to confirm.

6

Use the UP / DOWN buttons to select the minutes. Press the STOP to confirm.

7

Choose the command to be sent. Use the UP / DOWN buttons to select between the UP command, DOWN command, and Intermediate Position command. Press the STOP to confirm.

8

Choose the channels to add to the schedule. Use the arrow buttons (◀ / ▶) to move between channels, and the UP / DOWN buttons to select or deselect the channel. Press the STOP button to create the schedule.  
**Note: When the channel is blinking slow, the channel is not selected, and when the channel is blinking fast, the channel has been selected.**  
The schedule is now created.



## SCHEDULE DELETION

**1**

From the channels or groups screen, press and hold the circle button until **HIDE** or **DEL** appears on the screen. Press the circle button again three times until **DEL P** appears on screen.

**2**



Press the STOP button to enter the menu.

**3**

Select the schedule to be deleted and press the STOP button to confirm. The schedule is now deleted.

## CHANGING THE OPERATIONAL MODE

The remote operational mode can be changed between Automatic Mode [ **AUT** ], Random Mode [  ] and Manual mode [ **no icon** ].

The operational mode can be changed by quickly pressing the arrow buttons (  /  ) simultaneously. With each press of the button, the transmitter will change from manual to automatic, to random, to manual, etc. In automatic mode and random mode, the clock will appear on the screen instead of the channel or group lettering.

**Manual Mode:** The transmitter works only by sending up stop and down commands to channels or groups by manually pressing the button on the transmitter.

**Automatic Mode:** The transmitter will operate with manual control as well as executing schedules automatically.

**Random Mode:** The transmitter will operate with manual control and all schedules will execute with a delay from 0-30 minutes. For example, if the schedule is set to go off at 8:00, when in random mode, the schedule will go off anywhere between 8:00 and 8:30.

# BATTERY SUBSTITUTION

EMITTO SMART16



Remove the back cover then remove the exhausted battery.  
Insert the new battery respecting the correct polarity.

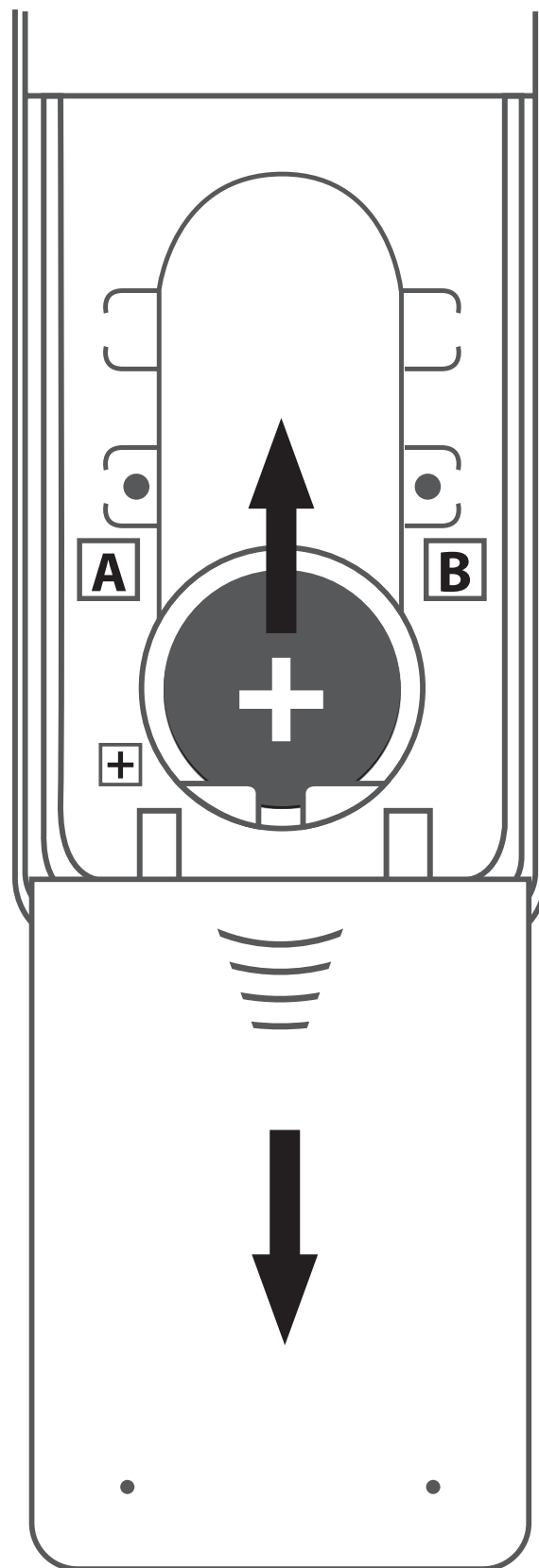

**IMPORTANT:** Battery contains polluting substances. After removing, throw it in the designated batteries collection points.

