

EMITTO SMART LINE

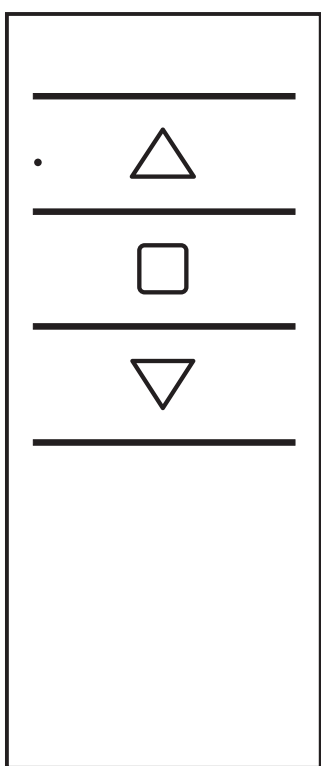

Transmitters

EMITTO SMART LINE transmitters enable the user to control one or more radio motors with receiver, installed on awnings, shutters and screens.



1 CHANNEL

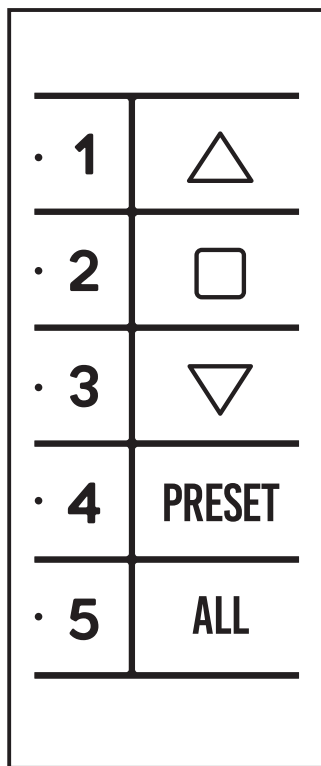

5 CHANNELS
PRESET / ALL

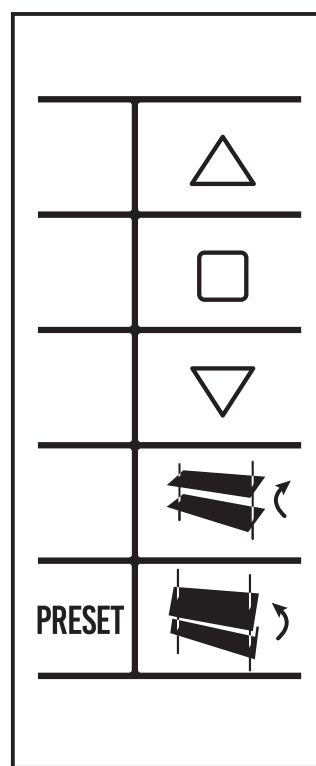

1 CHANNEL
TILTING / PRESET

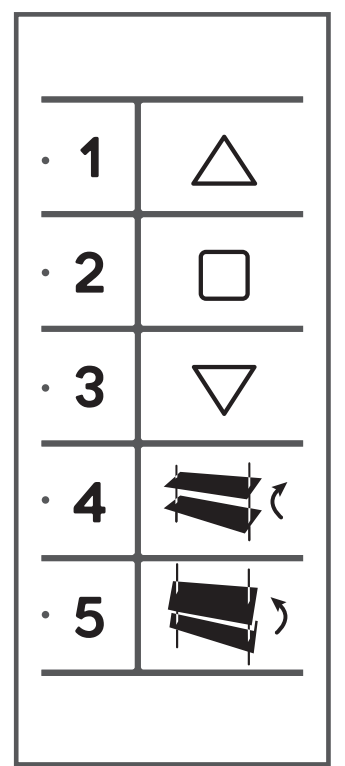

5 CHANNELS
TILTING

INDEX

TECHNICAL DETAILS

PUSHBUTTONS

BRACKETS

PROGRAMMING TRANSMITTER

ADDING TRANSMITTER

CHECKING/CHANGING DIRECTION

ERASING TRANSMITTER

RESET MOTOR MEMORY

LIMIT SWITCH SETUP

INTERMEDIATE POSITION

CHANNEL MANAGEMENT

BATTERY SUBSTITUTION



Battery	3V mod. CR2032
Channels	1/5
Encoding	RC Gaposa
Battery life	2 years
Frequency	868,30 MHz
Radiated power	0,150 mW
Protection rate	IP40
Coverage (int/ext)	20 m / 200 m
Working temperature	-5°C / +40°C

CAUTION: Please don't use these transmitters in areas with risks of radio disturbs over the norm (i.e. airports or radio repeaters). These transmitters may also be disturbed by telecommunication and/or transceiver systems with the same frequency.

NOTE: If the LED doesn't blink after the button pressure, then the battery has to be replaced.

PUSHBUTTONS

EMITTO SMARTLINE



QCTX01

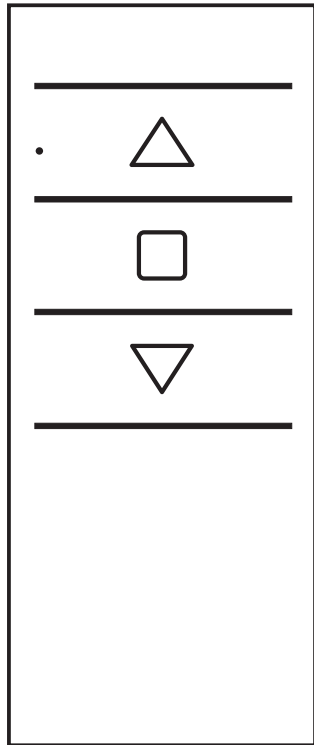

QCTX02

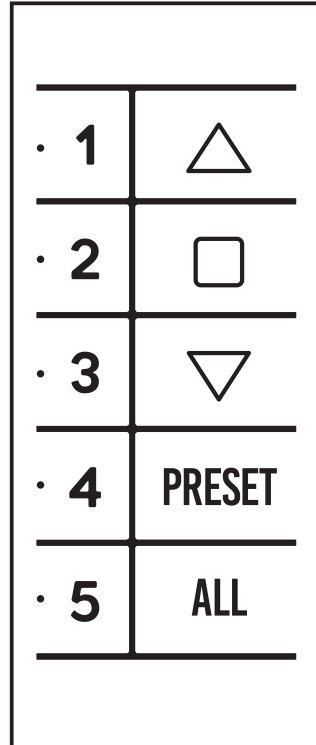

QCTX03

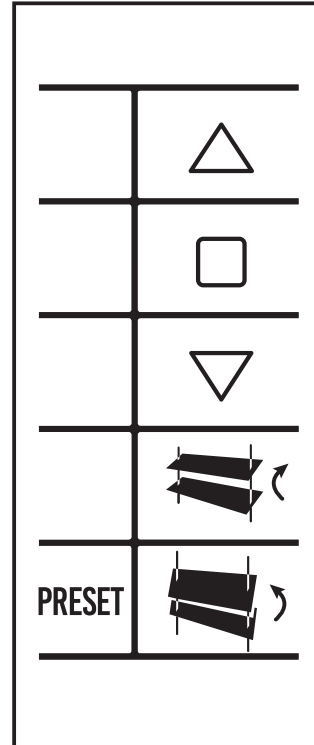

QCTX04

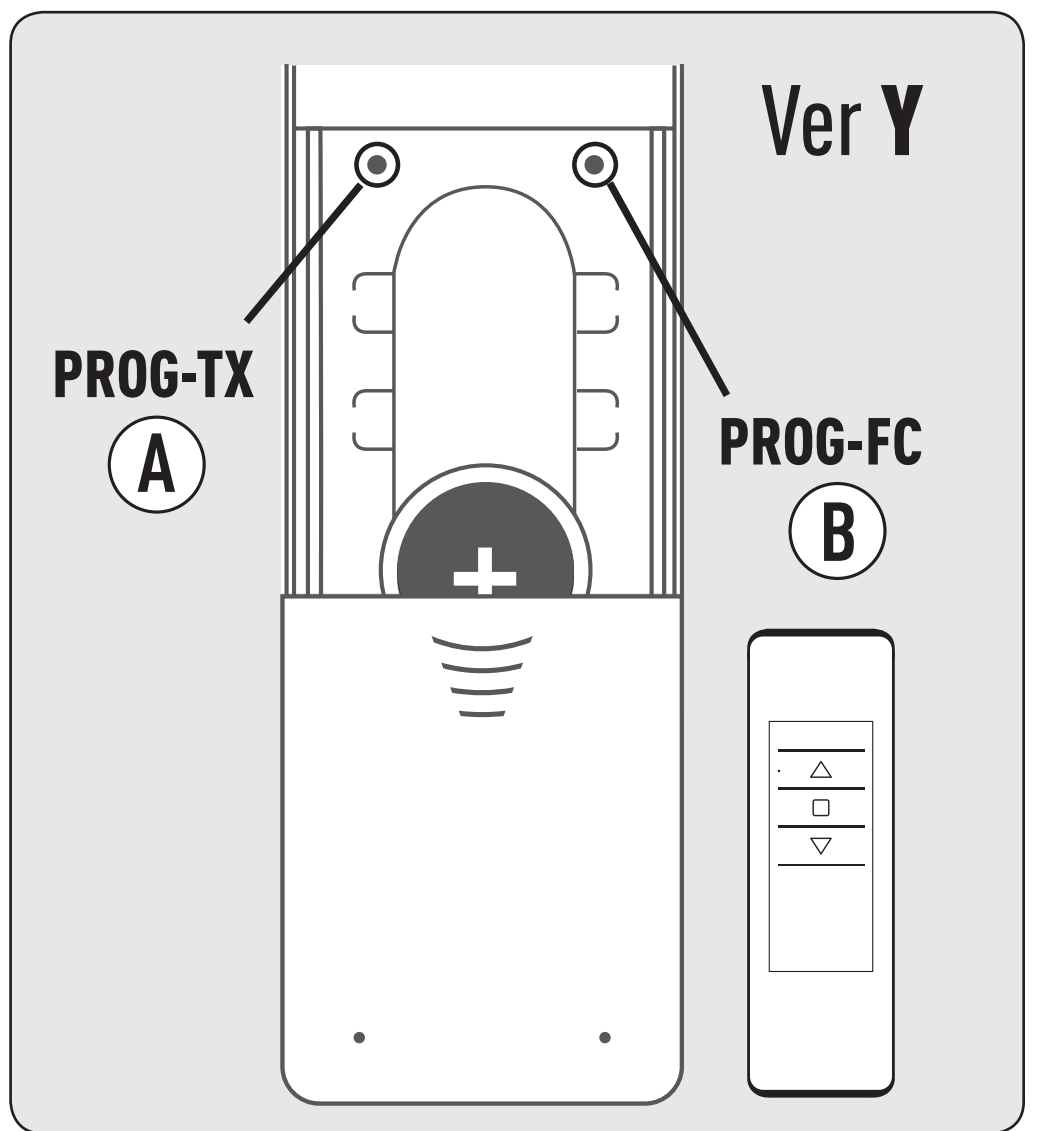
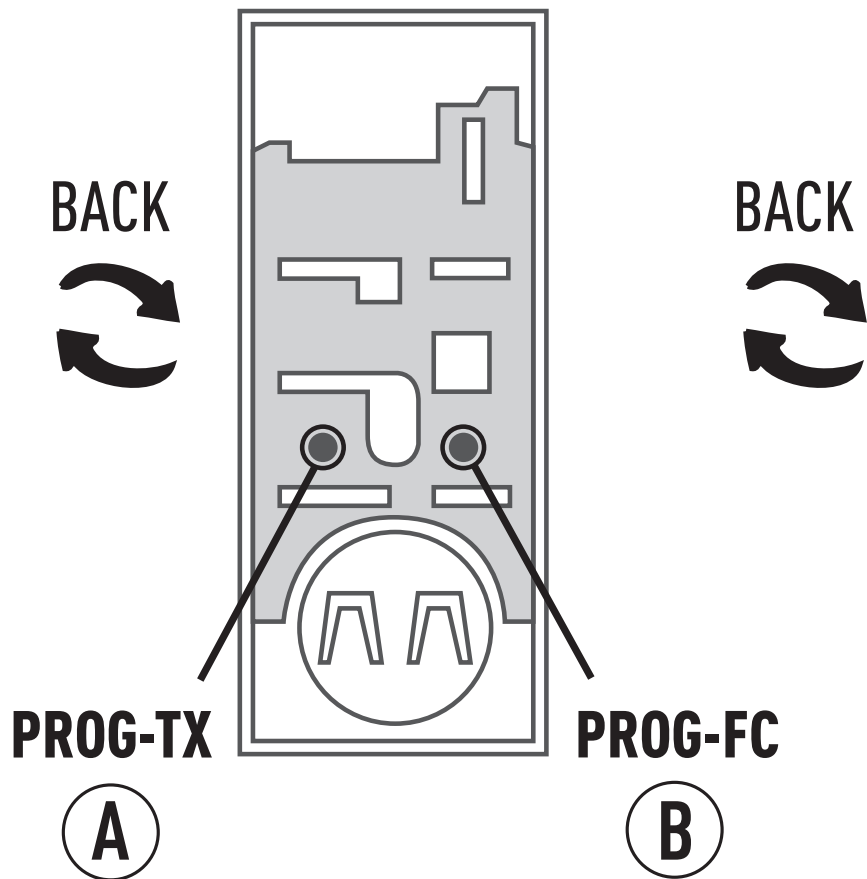
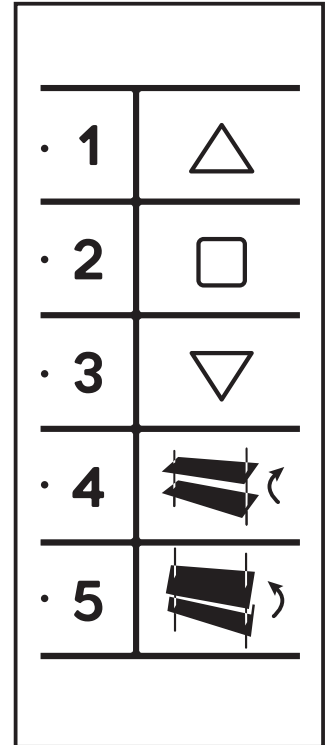

△ UP □ STOP ▽ DOWN

1 2 3
4 5 Select channel

Ⓐ **PROG-TX** Program the transmitter

PRESET intermediate position

Ⓑ **PROG-FC** Set the limit switch

ALL Select all channels

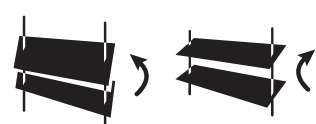

TILTING
Orientation of the slats

BRACKETS

EMITTO SMARTLINE



PORTABLE VERSIONS

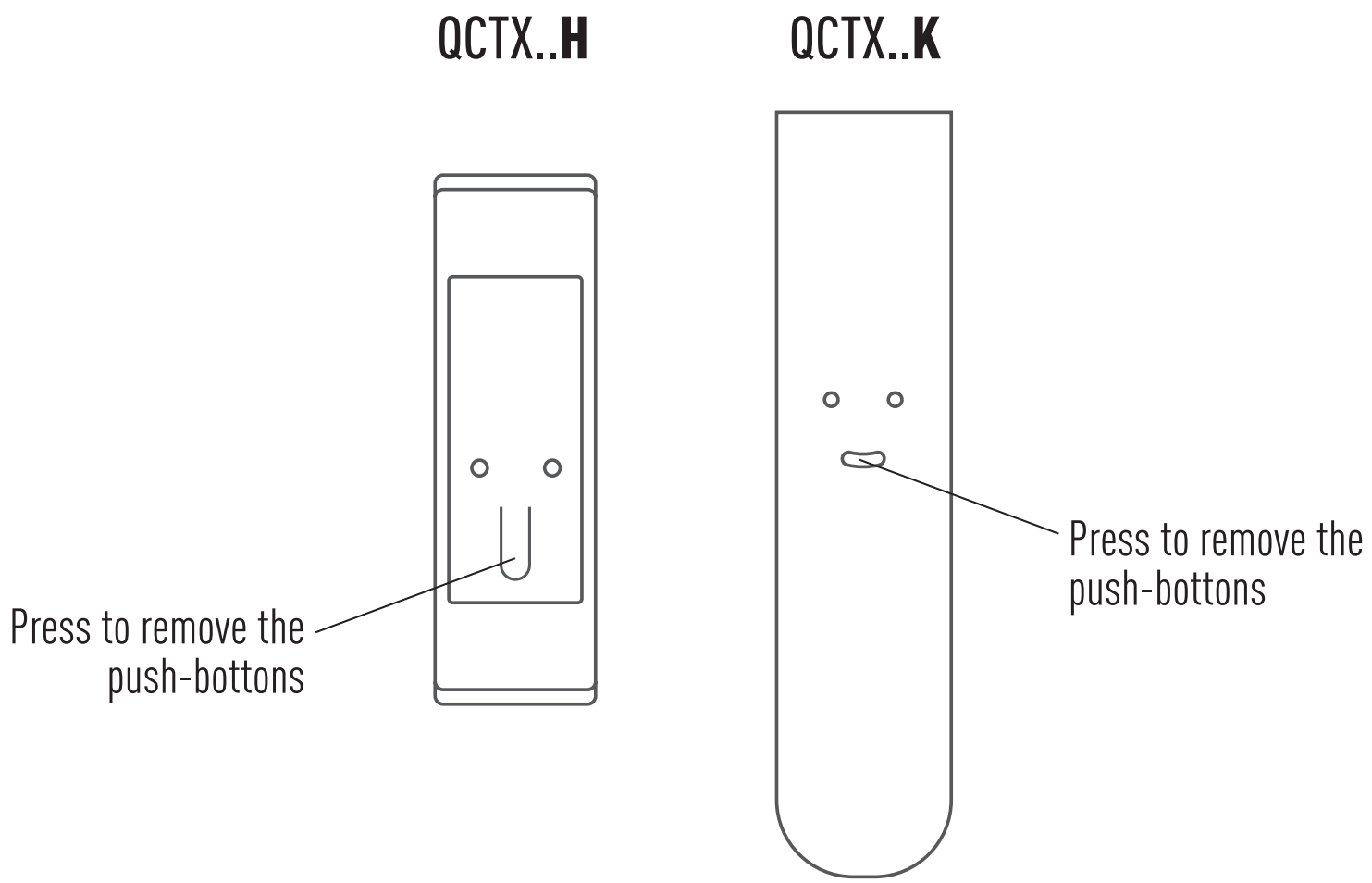

WALL MOUNTED VERSION

WALL INSTALLATION

Attach the support to the wall with screws (not included). Mount the pushbutton at the support lightly pressing until you hear a "click".

[D version] Mount the frame at the support lightly pressing until you hear a "click".

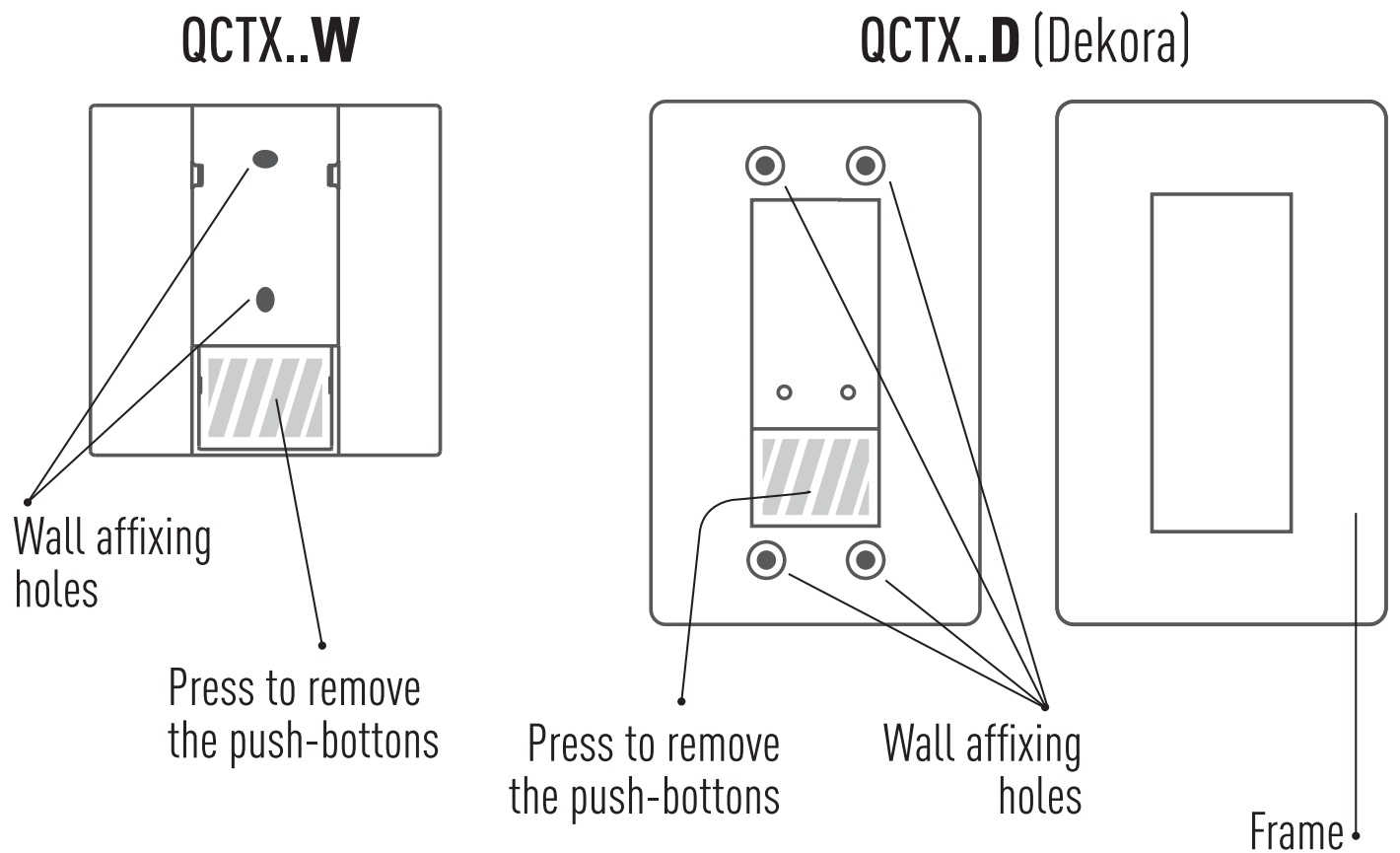

PORTABLE/WALL MOUNTED VERSION

WALL INSTALLATION

Attach the magnetic wall support to the wall with screw (not included).

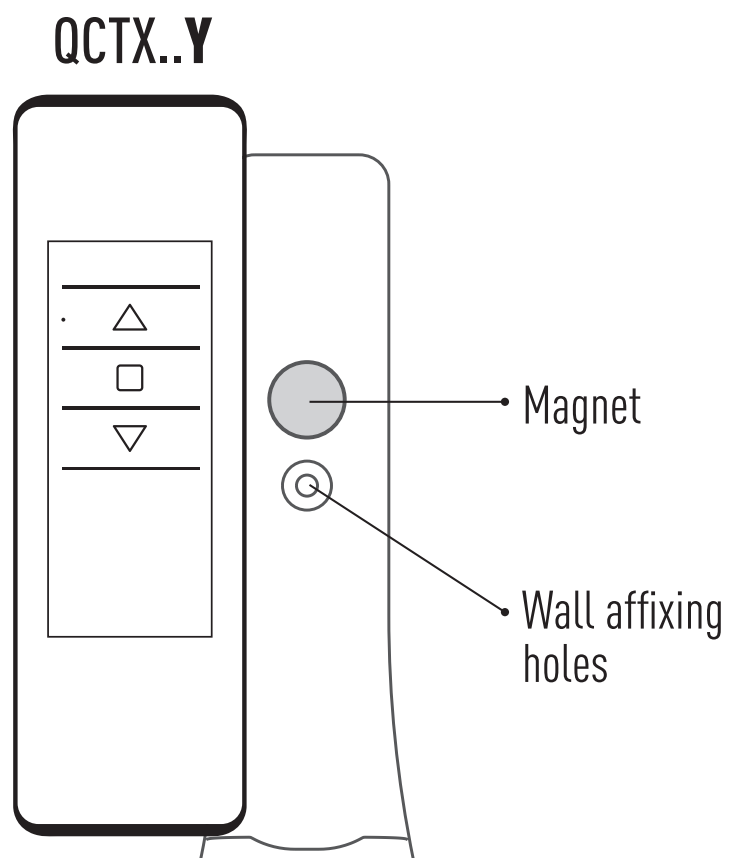



PROGRAMMING TRANSMITTER

CAUTION: If more motors with receiver have to be installed, it is important to power up **only one motor at time** during the first programming session, in order to avoid any interferences with others.

1

Power up the motor to be programmed.

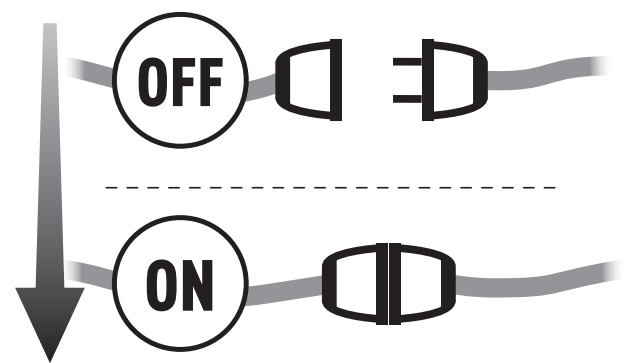

2

Press and hold the PROG-TX button until the motor starts moving.



3

Check the rotation of the motor, then release PROG-TX (the motor stops).

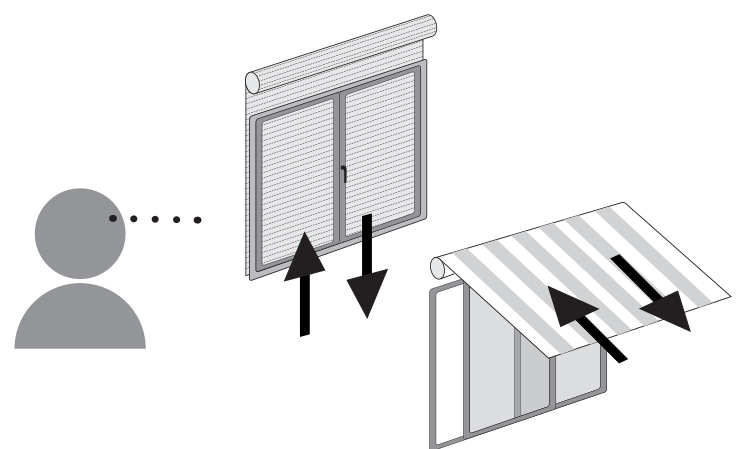

4

Within 5 seconds press the corresponding button (i.e. UP if the motor rotates upwards or DOWN if vice versa). The transmitter has been programmed and the rotation of the motor has been synchronized.

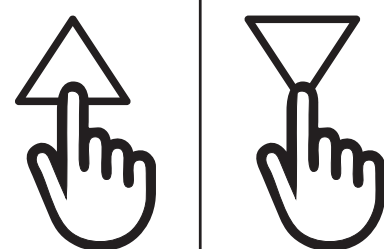



ADDING TRANSMITTER

1

Press and Hold the PROG-TX button of a transmitter **already paired** until the motor starts moving.

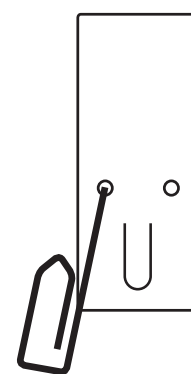
**2**

Check the rotation of the motor, then release the PROG-TX button (the motor stops).

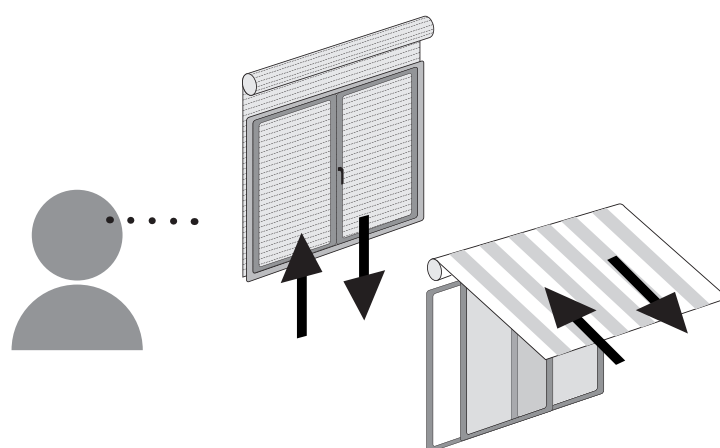
**3**

Within 5 seconds press the corresponding button (i.e. UP if the motor rotates upwards or DOWN if vice versa) on the **new transmitter being added**.

The new transmitter has been programmed and the rotation of the motor has been synchronized.

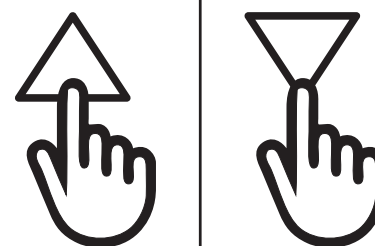



CHECKING/CHANGING DIRECTION

IMPORTANT: change direction must be performed before starting limit setting otherwise limits must be reset.

Press UP or DOWN the motor should go UP or DOWN, otherwise to change direction:

1

Press and hold the PROG-TX button until the motor starts moving

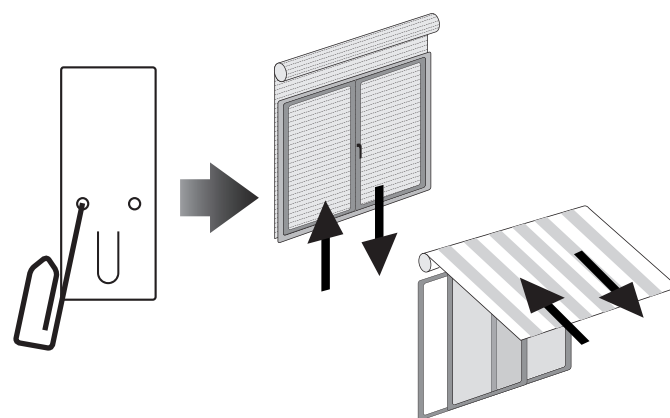
**2**

Press STOP: The motor makes a brief jog. Direction of the motor has been reversed.

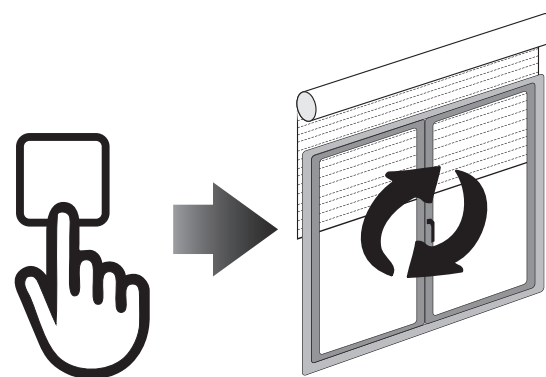



ERASING TRANSMITTER

Push simultaneously the PROG-TX button and STOP of the transmitter until the motor makes a brief movement in both directions.
Only the transmitter used for this procedure has been deleted from motor memory.

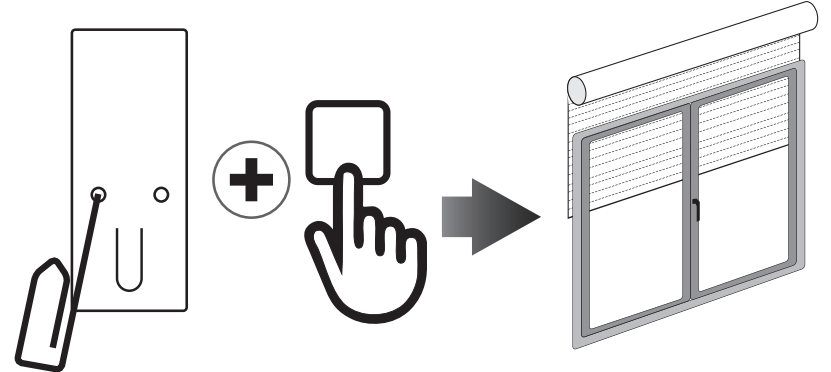

RESET MOTOR MEMORY

OPTION 1 - Using an already programmed transmitter

Press and hold both the PROG-TX and STOP buttons until the motor makes first a brief jog and, after a while, a second, long jog. Memory is now empty.

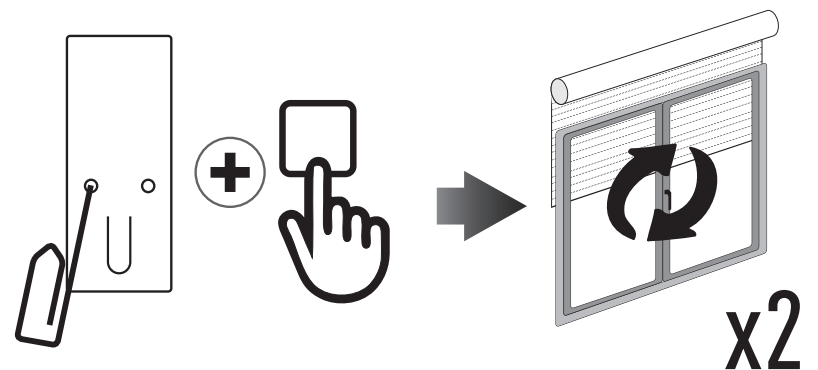

OPTION 2 - Without an already programmed transmitter

1

Switch the motor power supply OFF.
Then switch it ON.

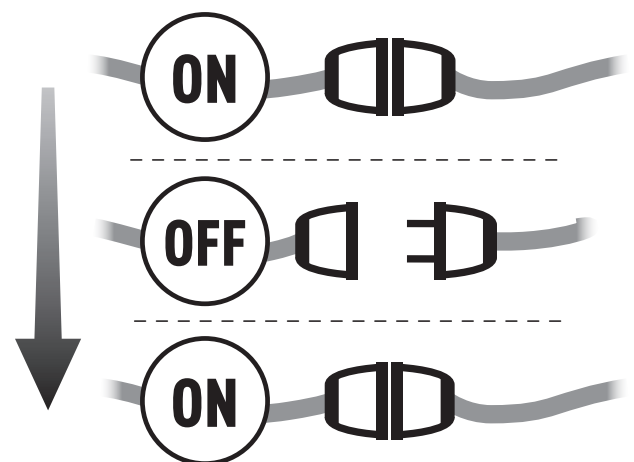

2

Within 8 seconds, using any Gaposá transmitter, press and hold both the PROG-TX and STOP buttons until the motor makes a long jog.
Memory is now empty.

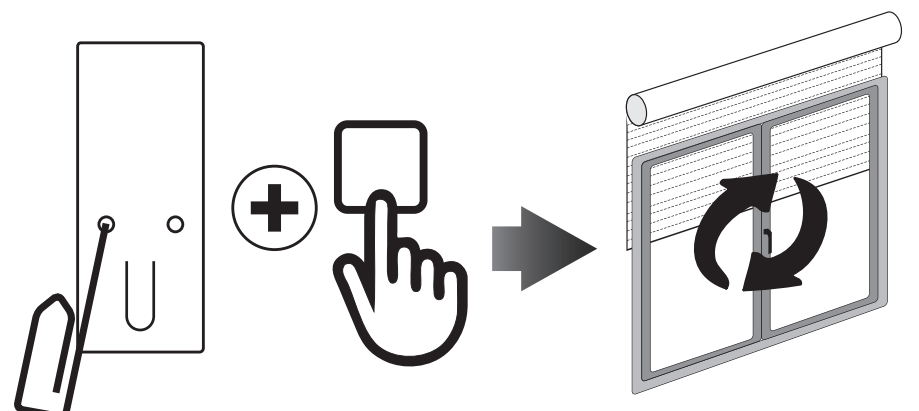

LIMIT SWITCH

EMITTO SMARTLINE



LIMIT SWITCH SETUP (Just for motors with electronic limit switch)

ATTENTION: ALWAYS SET THE UP LIMIT FIRST

1	Push the PROG-FC button until the motor makes a brief jog. Note: during “programming mode” the operations are in “deadman control”	
2	Press and hold the UP button and run the motor to the desired UP limit position.	
3	Press STOP to set the UP limit position. The motor makes a brief jog.	
4	Press and hold the DOWN button and run the motor to the desired DOWN limit position.	
5	Press STOP to set the DOWN limit position. The motor makes a brief jog.	

Note: accurate limit setting can be performed when UPWARD or DOWNWARD by pressing the PROG-FC button a second time. The motor then moves slowly in steps towards the desired limit. Always press STOP button to set the limit position.

AUTOMATIC SETTING OF THE LIMITS

For limits set with torque sensor (mechanical stop of shutters or cassette awnings/shades), press and hold UP button until the bottom bar hits the cassette or shutter box.

A short jog will indicate that the UP position has been memorized. The same procedure can be followed for DOWN limit but only for roller shutters.

INTERMEDIATE POSITION



INTERMEDIATE POSITION SETUP

(Just for motors with electronic limit switch)

1

Stop the shutter/awning in the desired intermediate position.

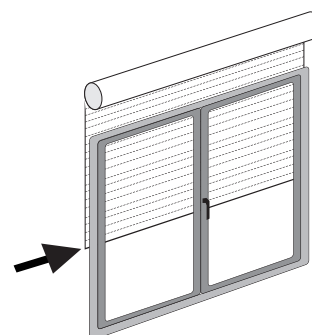

2

Press simultaneously the UP and DOWN buttons until the motor makes a brief movement in both directions. The intermediate position has been setup.

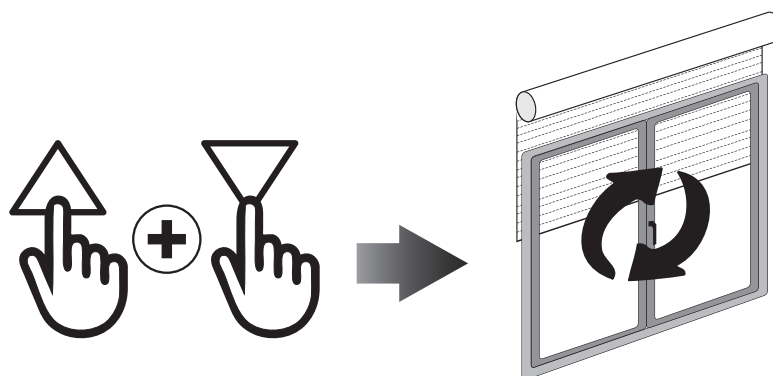

RECALLING THE INTERMEDIATE POSITION

[QCTX01/04] Keep the STOP button pressed at least for at least 3 seconds.

[QCTX02/03] Press the PRESET button.

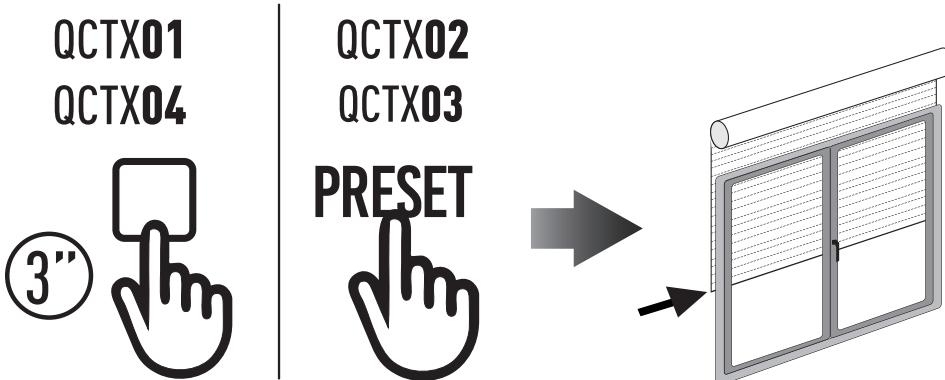

ERASING THE INTERMEDIATE POSITION

Press simultaneously, both the UP and DOWN buttons until the motor makes a brief movement in both directions.

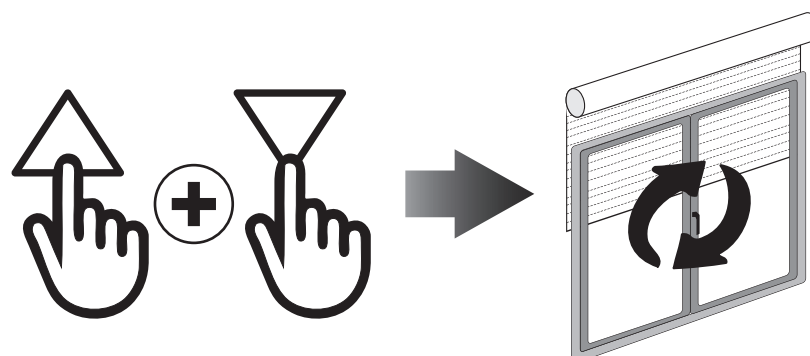



CHANNEL MANAGEMENT [5 channel version]

The channels are selected by pressing buttons 1, 2, 3, 4, 5 and are indicated by the corresponding LEDs. You can select multiple channels and memorize them by pressing STOP.

Once the selected channel / group has been selected, you can run the corresponding motor drive with the UP, STOP and DOWN keys. The emitters can memorize up to 8 channel group combinations. **Storing additional groups involves the cancellation of channels already stored starting from the earliest.**

SELECTING A MEMORIZED GROUP OF CHANNELS

With all LEDs off, press the ALL button to select all channels.

Pressing the ALL key again in sequence will repeat the last 8 selected groups according to this sequence:

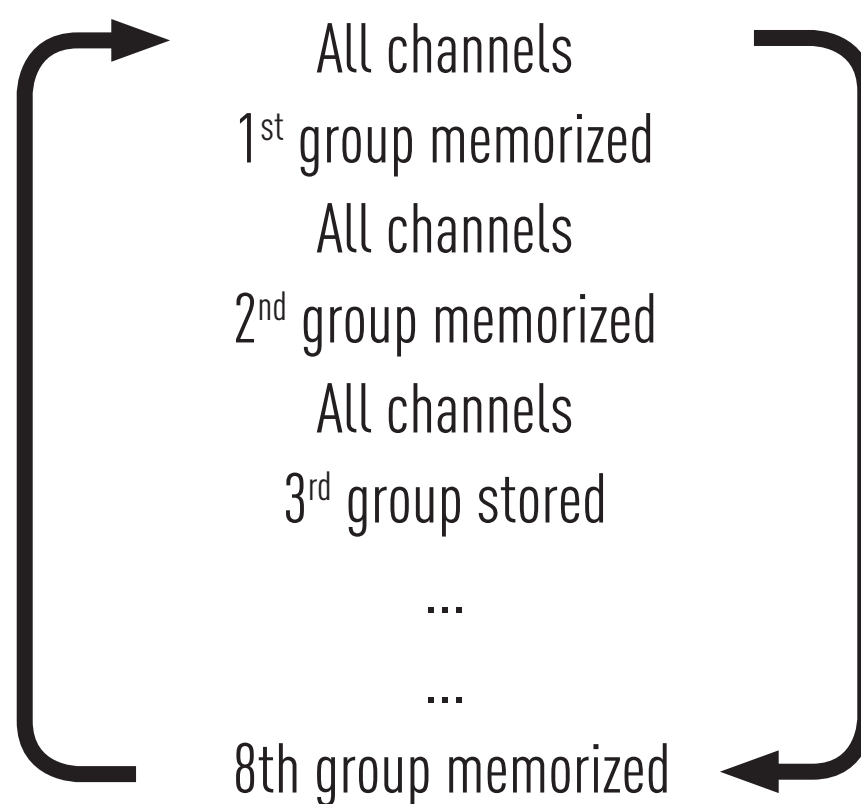

Once the selected group has been selected, you can run the corresponding motors with the UP, STOP, DESCENT buttons.

BATTERY SUBSTITUTION

EMITTO SMARTLINE



1. Remove the push-buttons (or the back cover in case of **Y** version) then remove the exhausted battery.
2. Insert the new battery respecting the correct polarity.

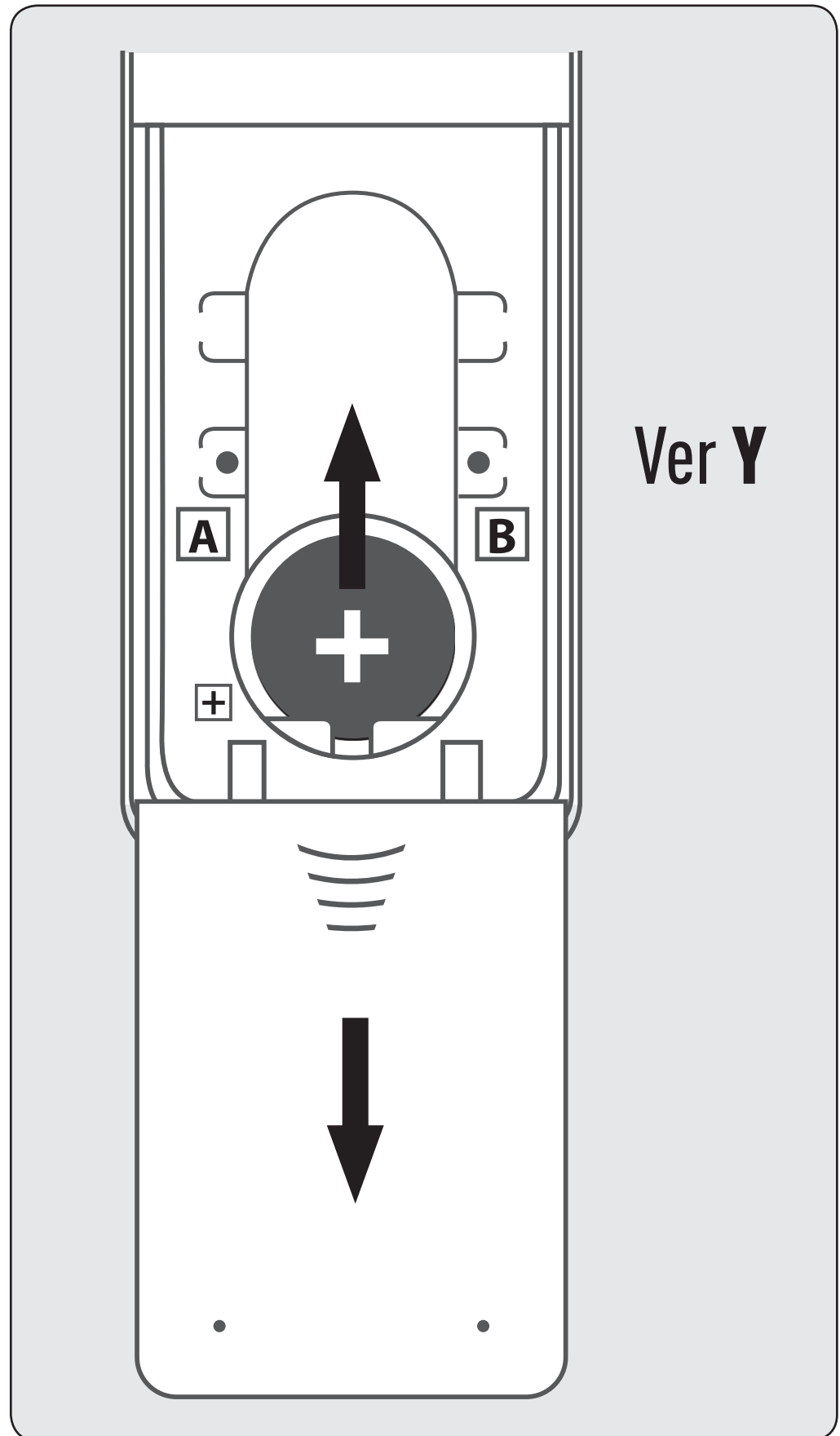
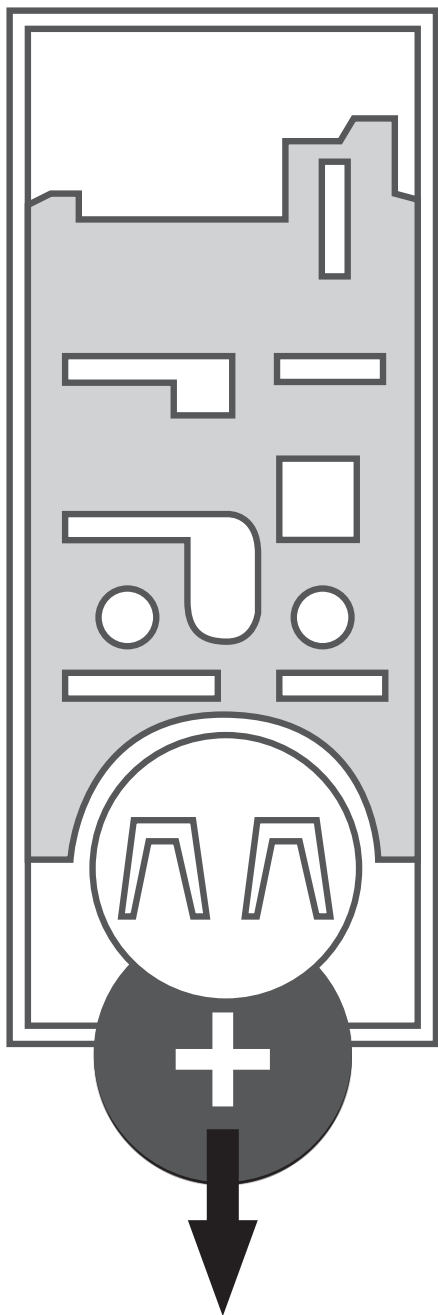

IMPORTANT: Battery contains polluting substances. After removing, throw it in the designated batteries collection points.

